



Groupe Group

SUPERTOURISME SUPERTOURING

FICHE D'HOMOLOGATION CONFORME A L'ANNEXE J DU CODE SPORTIF INTERNATIONAL HOMOLOGATION FORM IN ACCORDANCE WITH APPENDIX J OF THE INTERNATIONAL SPORTING CODE

Homologation valable à partir du 01 JAN. 1997 Homologation valid as from

A) Voiture vue de 3/4 avant Car seen from 3/4 front

B) Voiture vue de 3/4 arrière Car seen from 3/4 rear



1. GENERALITES / GENERAL

101. Constructeur Manufacturer Volvo Car Corporation

102. Dénomination(s) commerciale(s) - Modèle et type Commercial name(s) - Model and type Volvo S40

104. Mode de construction : a) Mode : Type of car construction : Type : [X] séparée / [X] separate [] monocoque / [] unitary construction

b) Matériau du châssis / coque Material of chassis / bodyshell Steel

105. Nombre de volumes Number of volumes 3

106. Nombre de places Number of places 5

© FISA - FC - 1994 - 048.01.FB.11.94

Fédération Internationale de l'Automobile logo and address: 8, place de la Concorde, 75008 Paris Services Administratifs: 8 bis, rue Boissy d'Anglas, 75008 Paris

SVENSKA BILSPORTFÖRBUNDET THE SWEDISH AUTOMOBILE SPORT FEDERATION

Marque Volvo
MakeModèle S40
Model**ST 32**A9) Coque vue de 3/4 avant, sans portes, capots, etc.
Bodyshell seen from 3/4 front without doors, lids, etc.A10) Coque vue de 3/4 arrière, sans portes, capots, etc.
Bodywork seen from 3/4 rear without doors, lids, etc.**2. DIMENSIONS, POIDS / DIMENSIONS, WEIGHT**202. Longueur hors-tout 4483 mm +/- 1 %
Overall length203. Largeur hors-tout 1717 mm +/- 1 %
Overall widthEndroit de mesure At rear door
Where measured

204. Largeur de carrosserie Width of bodywork	a) A la hauteur de l'axe avant At front axle	<u>1683</u>	mm +/- 1%
	b) A la hauteur de l'axe arrière At rear axle	<u>1703</u>	mm +/- 1%

206. Empattement 2550 mm +/- 1 %
Wheelbase

209. Porte-à-faux Overhang	a) Avant Front	<u>910</u>	mm +/- 1 %	b) Arrière Rear	<u>1023</u>	mm +/- 1 %
-------------------------------	-------------------	------------	------------	--------------------	-------------	------------

210. Distance "G" (volant - paroi de séparation arrière) 1595 mm
Distance "G" (steering wheel - rear bulkhead)**FEDERATION INTERNATIONALE
DE L'AUTOMOBILE**

8, place de la Concorde, 75008 Paris

Services Administratifs :

8 bis, rue Boissy d'Anglas, 75008 Paris

Marque / Make Volvo Modèle / Model S40

ST 32

4. CIRCUIT DE CARBURANT / FUEL CIRCUIT

401. Réservoir : b) Emplacement
 Fuel tank : Location Located between the rear wheels under the floor

6. TRANSMISSION / POWER TRAIN

601. Roues motrices : avant

oui	non
yes	no

 arrière

oui	non
yes	no

 Driven wheels : front rear

603. Boîte de vitesses : a1) Emplacement dans l'empattement

moitié avant	moitié arrière
front half	rear half

 Gearbox : Location in wheelbase

XII) CHAÎNE CINÉMATIQUE (4 roues motrices) / KINEMATIC TRAIN (4 wheel drive) :

**FEDERATION INTERNATIONALE
 DE L'AUTOMOBILE**

8, place de la Concorde, 75008 Paris

Services Administratifs :

8 bis. rue Boissy d'Anglas, 75008 Paris

Marque
Make VolvoModèle
Model S40**ST 32**

Modifications nécessaires pour passer d'une version 2 roues motrices (au moins 2500 exemplaires) à une version 4 roues motrices (au moins 2500 exemplaires) / Modifications necessary in order to go from a 2-wheel drive version (at least 2500 cars) to a 4-wheel drive version (at least 2500 cars)

**FEDERATION INTERNATIONALE
DE L'AUTOMOBILE**

8, place de la Concorde, 75008 Paris

Services Administratifs :

8 bis, rue Boissy d'Anglas, 75008 Paris

SVENSKA BILSPORTFÖRBUNDET
THE SWEDISH AUTOMOBILE-SPORT FEDERATION

Marque
Make VolvoModèle
Model S40**ST 32**

7. SUSPENSION / SUSPENSION

	Avant / Front	Arrière / Rear
701. Généralités General		
a) Type de suspension Type of suspension	<u>McPherson</u>	<u>Multi-link indipendant</u>
702. Ressorts hélicoïdaux Helicoïdal springs	<input type="checkbox"/> oui <input checked="" type="checkbox"/> yes	<input checked="" type="checkbox"/> non <input type="checkbox"/> no
703. Ressorts à lames Leaf springs	<input checked="" type="checkbox"/> oui <input type="checkbox"/> yes	<input type="checkbox"/> non <input checked="" type="checkbox"/> no
704. Barres de torsion Torsion bars	<input checked="" type="checkbox"/> oui <input type="checkbox"/> yes	<input type="checkbox"/> non <input checked="" type="checkbox"/> no

705. Autre type de suspension : *Voir description sur fiche additionnelle*
Other type of suspension : *See description on additional form*

	Avant / Front	Arrière / Rear
707. Amortisseurs : Shock absorbers :		
a) Nombre par roue Number per wheel	<u>one</u>	<u>one</u>

T) Train avant complet déposé
Complete dismantled front axle

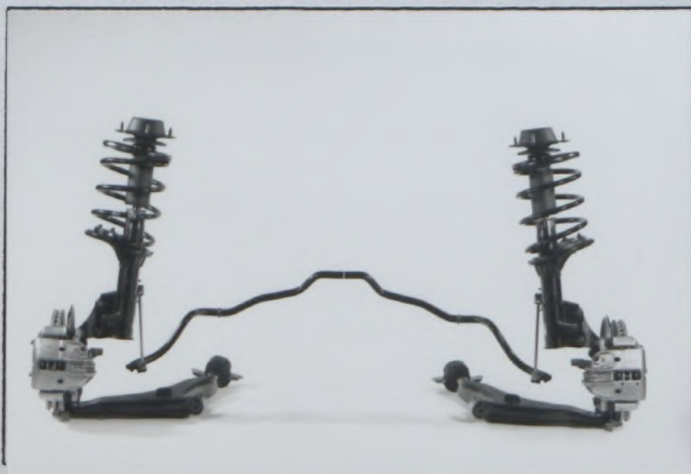

U) Train arrière complet déposé
Complete dismantled rear axle

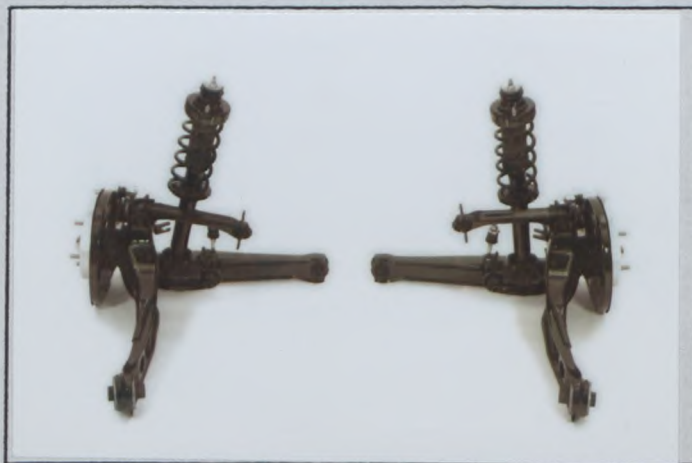

8. TRAIN ROULANT / RUNNING GEAR

	Avant / Front	Arrière / Rear
804. Direction : Steering :		
a) Type Type	<u>Rack and pinion</u>	<u>FEDERATION INTERNATIONALE DE L'AUTOMOBILE</u>

8, place de la Concorde, 75008 Paris
Services Administratifs :
8 bis, rue Boissy d'Anglas, 75008 Paris

Marque • Volvo
MakeModèle S40
Model

ST 32.

9. CARROSSERIE / BODYWORK

- X) Tableau de bord
-
- Dashboard



902. Extérieur :
-
- Exterior :

a) Nombre de portes 4
Number of doorsb) Hayon
Tailgate

<input checked="" type="checkbox"/> oui	<input type="checkbox"/> non
<input checked="" type="checkbox"/> yes	<input type="checkbox"/> no

- c) Matériau des portières
-
- Door material

Avant / Front	Arrière / Rear
<u>Steel</u>	<u>Steel</u>

- d) Matériau du capot avant
-
- Front bonnet material

Steel

- e) Matériau du capot arrière / hayon
-
- Rear bonnet / tailgate material

Steel

- f) Matériau de la carrosserie
-
- Bodywork material

Steel

- h) Matériau de lunette arrière
-
- Rear window material

Tempered glass

- i) Matériau des glaces de custode
-
- Rear quarter window material

Tempered glass

- k) Matériau des vitres latérales
-
- Side window material

Avant / Front	Arrière / Rear
<u>Tempered glass</u>	<u>Tempered glass</u>
<u>PP/EPDM/steel</u>	<u>PP/FPDM/steel</u>

- l) Matériau du pare-choc
-
- Material of bumper

PP/EPDM/steelPP/FPDM/steelFEDERATION INTERNATIONALE
DE L'AUTOMOBILE

8, place de la Concorde, 75008 Paris

Services Administratifs :

8 bis, rue Boissy d'Anglas, 75008 Paris

XIII) PARTIES DE CARROSSERIE SYNTHETIQUES / SYNTHETIC PARTS OF THE BODY :

 Synthetic parts

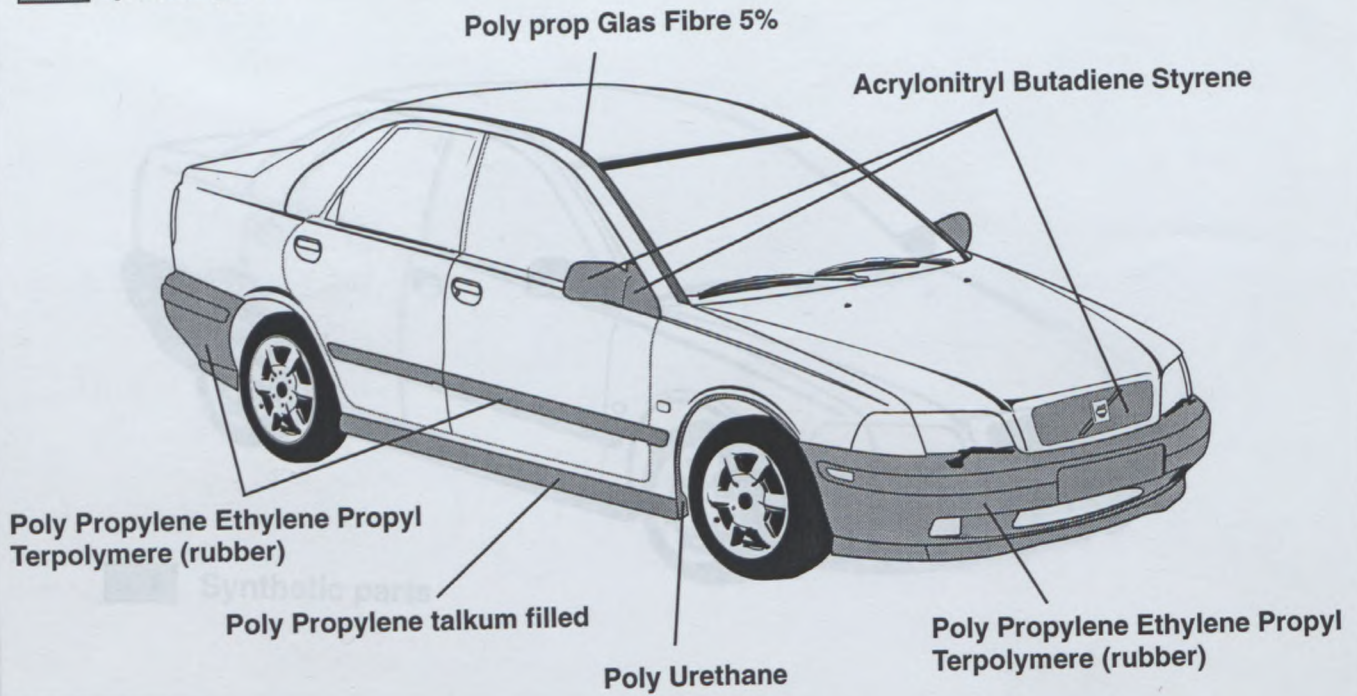

INFORMATIONS COMPLEMENTAIRES / COMPLEMENTARY INFORMATION :

**FEDERATION INTERNATIONALE
DE L'AUTOMOBILE**

8, place de la Concorde, 75008 Paris

Services Administratifs :

9 bis rue Boissy d'Anglas, 75008 Paris



FEDERATION INTERNATIONALE DE L'AUTOMOBILE

Homologation No
ST 32

Groupes **A/B/N/T1/** Supertourisme
Group **Supertouring**

Extension No

CERTIFICAT DE DIMENSIONS INTERIEURES
CERTIFICATE FOR INTERIOR DIMENSIONS

Véhicule: Constructeur Volvo Car Corporation Modèle et type Volvo S40
Vehicle: Manufactureur _____ Model and type _____

Dimensions intérieures comme définies par le Règlement d'Homologation
Interior dimensions as defined by the Homologation Regulations

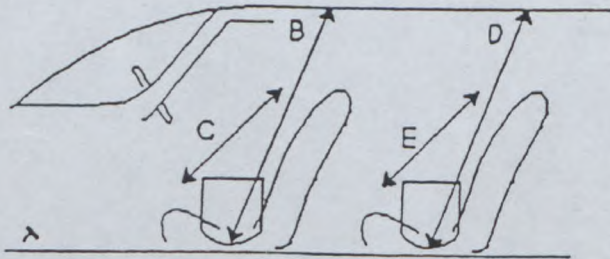

B	(Hauteur sur sièges avant) (Height above front seats)	<u>982</u> mm
C	(Largeur aux sièges avant) (Width at front seats)	<u>1312</u> mm
D	(Hauteur sur sièges arrière) (Height above rear seats)	<u>945</u> mm
E	(Largeur aux sièges arrière) (Width at rear seats)	<u>1312</u> mm

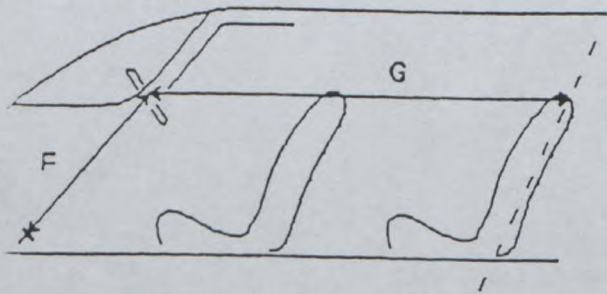

F	(Volant - Pédale de frein) (Steering wheel - Brake pedal)	<u>651</u> mm
G	(Volant - paroi de séparation arrière) (Steering wheel - rear bulkhead)	<u>1595</u> mm
H	$H = F + G =$	<u>2246</u> mm

**FEDERATION INTERNATIONALE
DE L'AUTOMOBILE**

8, place de la Concorde, 75008 Paris

Services Administratifs :

2 bis rue Boissy d'Anglas, 75008 Paris



FEDERATION INTERNATIONALE
DE L'AUTOMOBILE

Homologation No

ST 32

Groupe **ST**
Group

Véhicule: Constructeur Volvo Car Corporation Modèle et type Volvo S40
Vehicle: Manufactureur

Homologation valable à partir du _____
Homologation valid as from

705. Suspension :
Suspension : Front

X) Dessin de la suspension
Drawing of the suspension

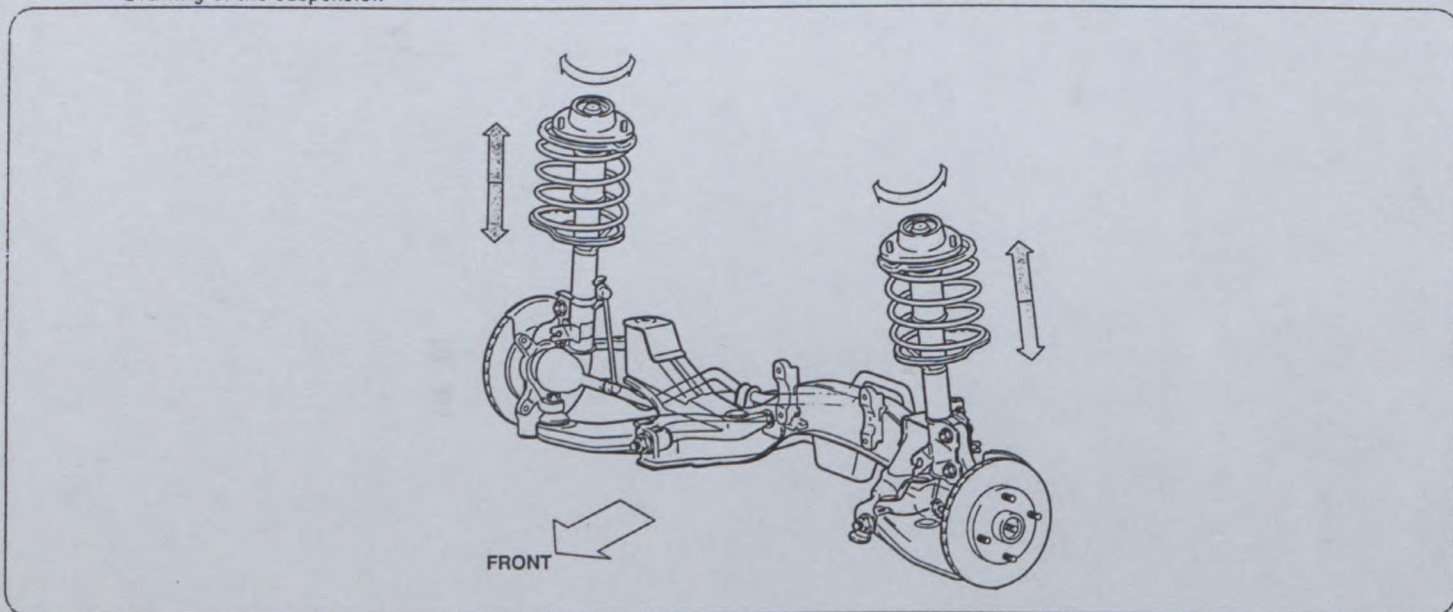

Description :
Description : McPherson

FEDERATION INTERNATIONALE
DE L'AUTOMOBILE

8, place de la Concorde, 75008 Paris

Services Administratifs :

8 bis rue Boissy d'Anglas, 75008 Paris



FEDERATION INTERNATIONALE DE L'AUTOMOBILE

Homologation No

ST 32

Groupe Group ST

Véhicule: Constructeur Volvo Car Corporation Modèle et type Volvo S40
Vehicle: Manufactureur Model and type

Homologation valable à partir du Homologation valid as from

705. Suspension : Suspension : Rear

X) Dessin de la suspension Drawing of the suspension

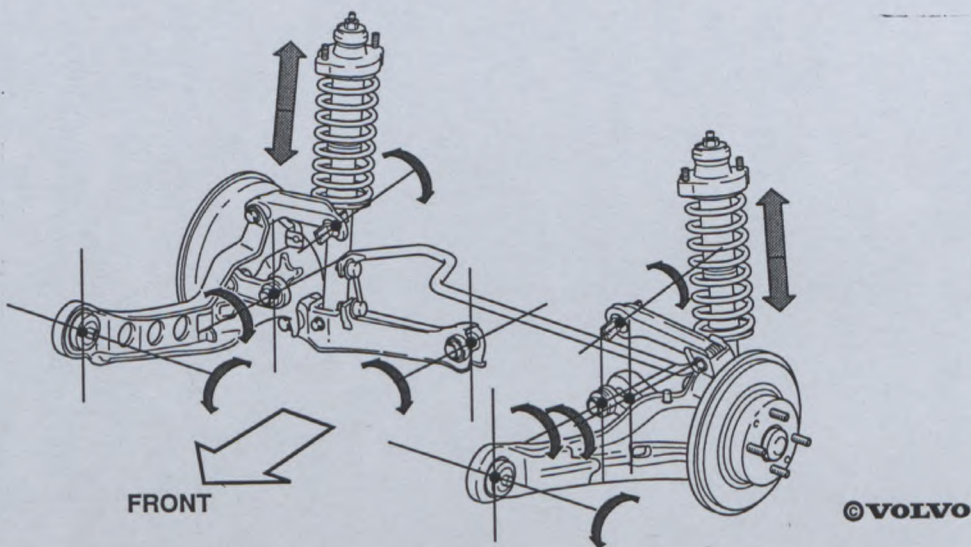

Description : Multi-link indipendant

© FISA - FC - 1990 - 009.02.FB.04.94

FEDERATION INTERNATIONALE DE L'AUTOMOBILE
8, place de la Concorde, 75008 Paris
Services Administratifs :
8 bis, rue Boissy d'Anglas, 75008 Paris

SVENSKA MOTORSPORTFÖRBUNDET
THE SWEDISH MOTORSPORT ASSOCIATION



FEDERATION INTERNATIONALE DE L'AUTOMOBILE

Homologation No

ST 32

Group
Group

A/B/N/T1

**Supertourisme
Supertouring**

Extension No

01/01V0

FICHE D'EXTENSION D'HOMOLOGATION FORM OF HOMOLOGATION EXTENSION

ES Evolution sportive du type / Sporting evolution of the

VO Variante option / Option variant

ET Evolution normale du type / Normal evolution of the

ER Erratum / Erratum

VF Variante de fourniture / Supply variant

Véhicule: Constructeur Volvo Car Corporation
Vehicle: Manufactureur

Modèle et type Volvo S40
Model and type

Homologation valable à partir du 01 MARS 1997
Homologation valid as from

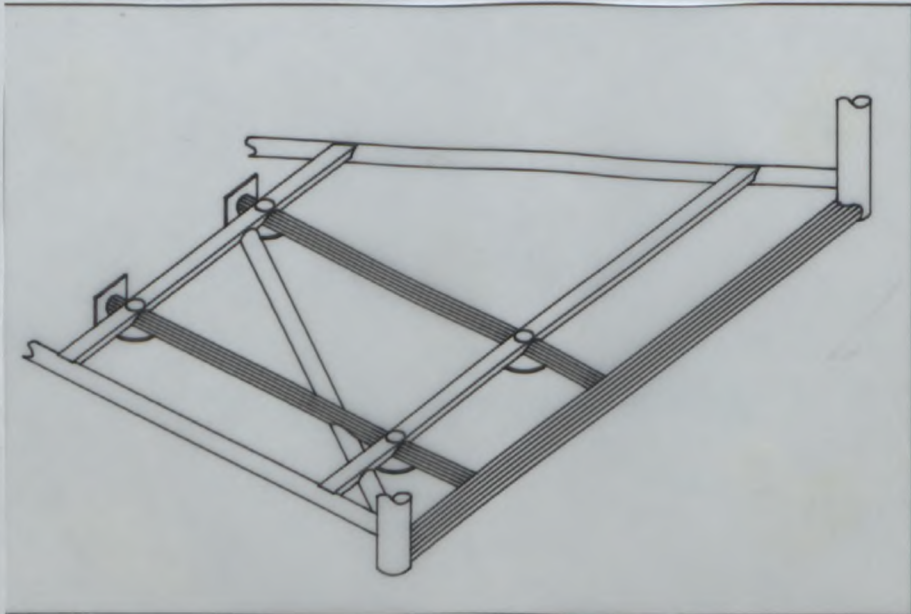
Page ou ext. Page or ext.	Article Article	Description Description
		

Handwritten signature
**FEDERATION INTERNATIONALE
 DE L'AUTOMOBILE**
 8, place de la Concorde, 75008 Paris
 Services Administratifs :
 8 bis, rue Boissy d'Anglas, 75008 Paris

Marque / Make Volvo

Modèle / Model S40

Homologation No
ST 32

Extension No
01/01V0

PHOTO No

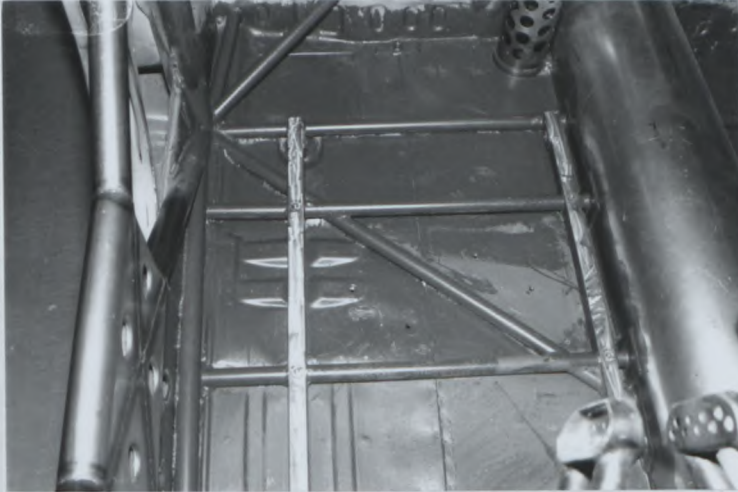

PHOTO No



PHOTO No

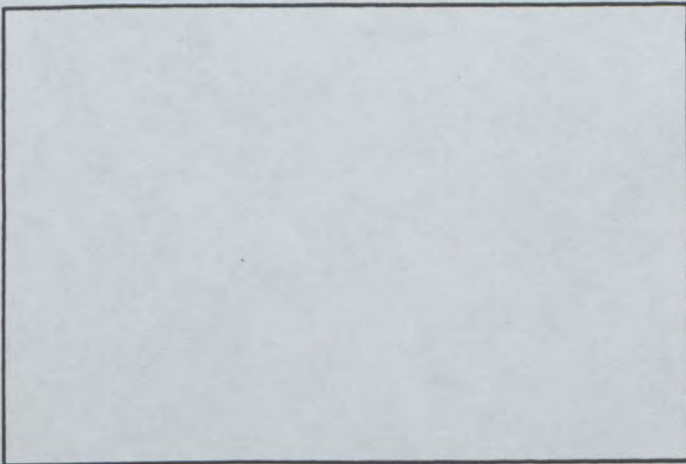

PHOTO No

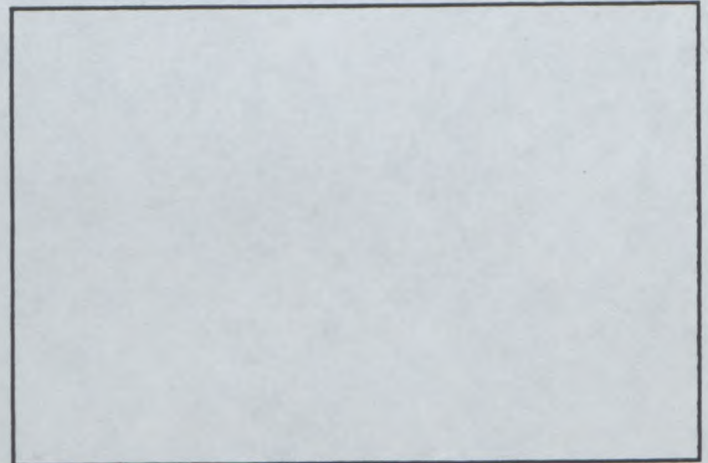

PHOTO No

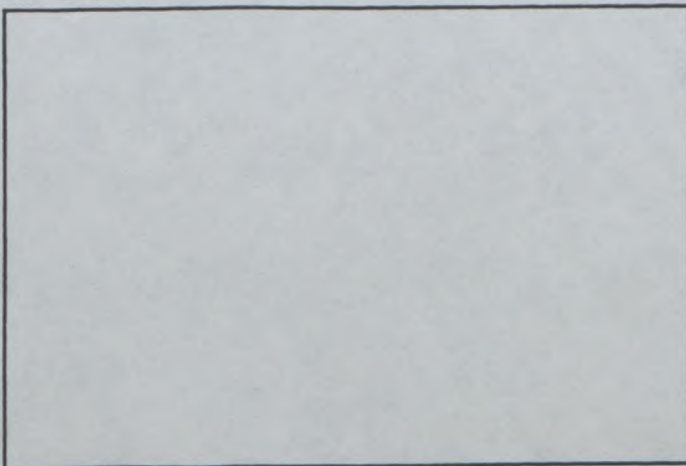
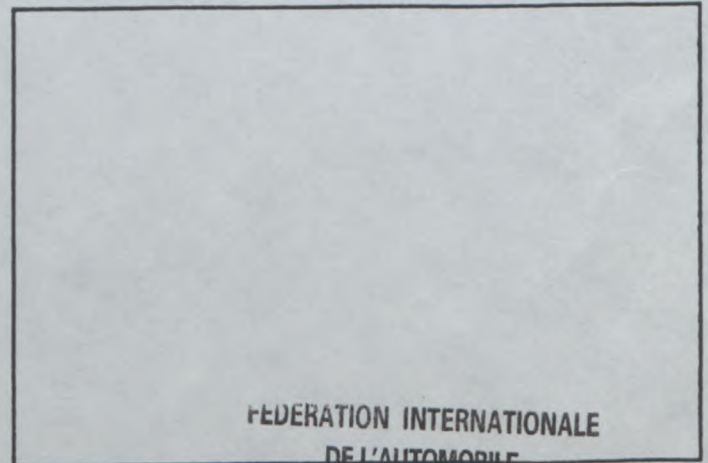

PHOTO No



**FEDERATION INTERNATIONALE
DE L'AUTOMOBILE**

8, place de la Concorde, 75008 Paris

Services Administratifs :

8 bis, rue Boissy d'Anglas, 75008 Paris

SVENSKA BILSPORTFÖRBUNDET
THE SWEDISH AUTOMOBILE SPORT FEDERATION



FEDERATION INTERNATIONALE
DE L'AUTOMOBILE

Homologation No

ST 32

Groupes
Group

Supertourisme
Supertouring

Extension No

02/02VO

FICHE D'EXTENSION D'HOMOLOGATION POUR ARMATURE DE SECURITE
FORM OF HOMOLOGATION EXTENSION FOR SAFETY CAGE

VO Variante option / Option variant

Véhicule: Constructeur Volvo Car Corporation Modèle et type Volvo S40
Vehicle: Manufactureur Volvo Car Corporation Model and type Volvo S40

Homologation valable à partir du
Homologation valid as from

01 MARS 1997

	Arceau principal Main rollbar	Entretoise longitudinale Longitudinal strut	Entretoise diagonale Diagonal Strut	Arceau avant Front rollbar
Matériau Material	<u>STEEL</u>	<u>STEEL</u>	<u>STEEL</u>	<u>STEEL</u>
Diamètre extérieur Exterior diameter	<u>44.4</u> mm	<u>44.4</u> mm	<u>38.1</u> mm	<u>44.4</u> mm
Epaisseur de paroi Wall thickness	<u>1.2</u> mm	<u>1.2</u> mm	<u>0.9</u> mm	<u>1.2</u> mm
Limite élastique Elastic limit	<u>62</u> daN/mm ²	<u>62</u> daN/mm ²	<u>62</u> daN/mm ²	<u>62</u> daN/mm ²
Résistance à la traction Tensile strength	<u>70-90</u> daN/mm ²	<u>70-90</u> daN/mm ²	<u>70-90</u> daN/mm ²	<u>70-90</u> daN/mm ²

All connections welded to bodyshell.

Fabricant de l'armature TWR RACING LTD Poids total y compris les fixations 43.5 kg
Structure manufacturer TWR RACING LTD Total weight including fixations 43.5 kg

Armature complète hors de la voiture
Complete structure outside the car

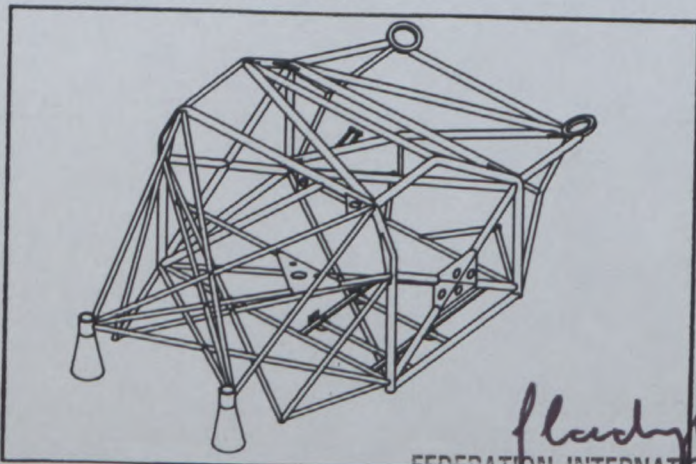

Nous attestons que la présente armature de sécurité répond aux dispositions de l'Annexe J de la FIA, en particulier en ce qui concerne ses implantations, ses connexions, et ses résistances aux contraintes.

We certify that the present safety structure complies with the conditions of the FIA Appendix J, in particular with regard to its attachments, its connections, and its stress resistances.

Signature du représentant du constructeur du véhicule
Signature of the car manufacturer representative

HANS GUSTAVSSON

FEDERATION INTERNATIONALE
DE L'AUTOMOBILE

8, place de la Concorde, 75008 Paris
Services Administratifs :
8 bis, rue Boissy d'Anglas, 75008 Paris

Marque Volvo
Make

Modèle S40
Model

Homologation No

ST 32

Extension No

02/02VO

PHOTO No

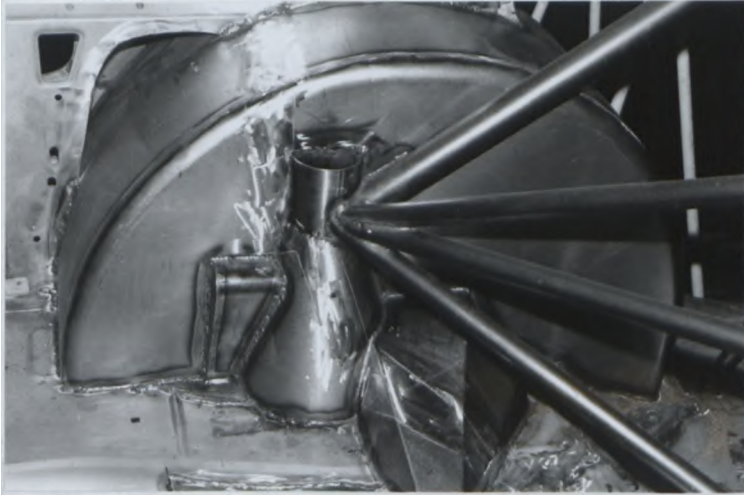

PHOTO No

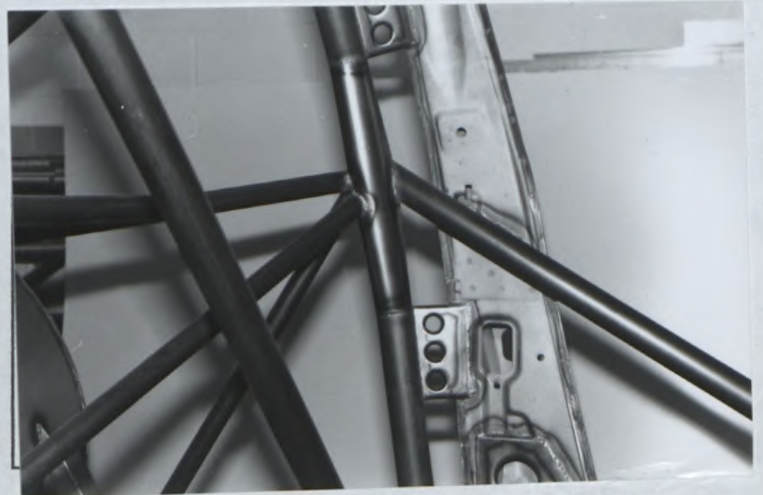

PHOTO No

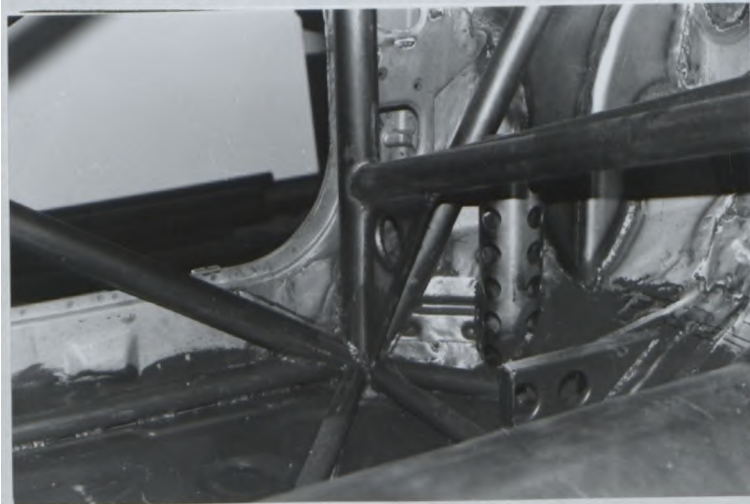

PHOTO No

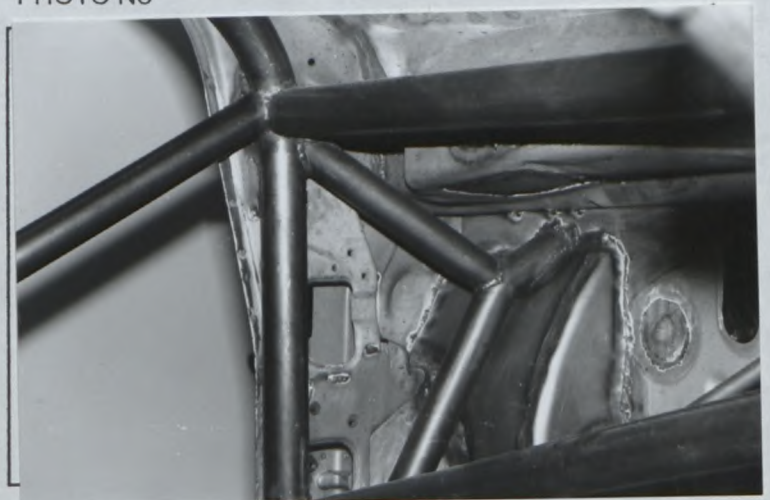

PHOTO No

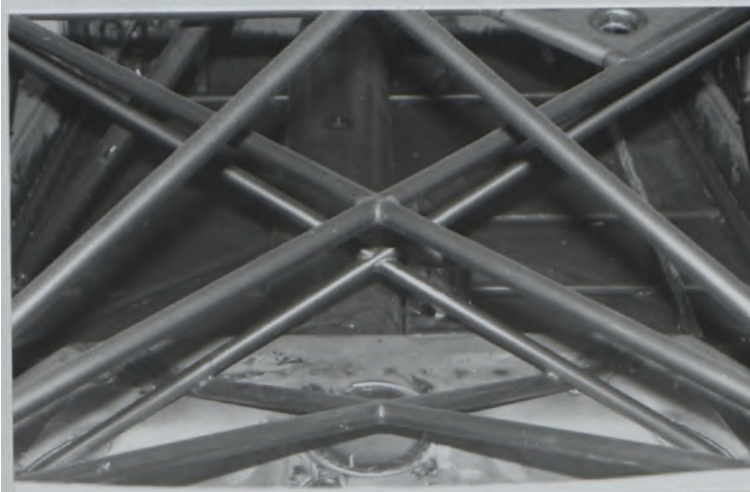
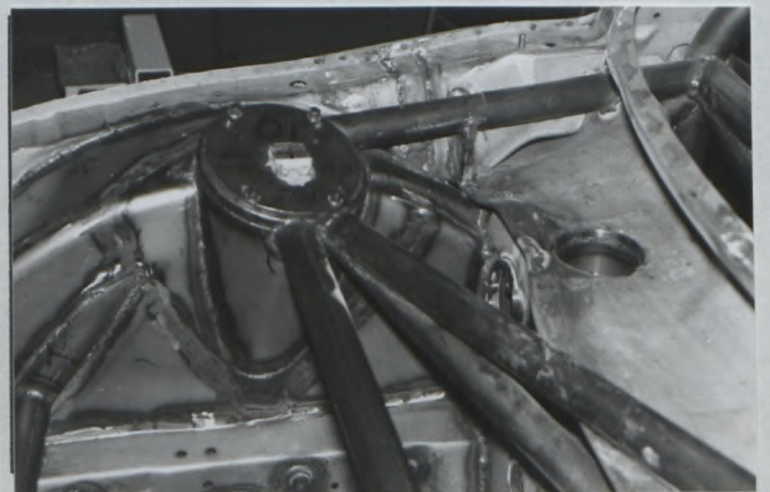

PHOTO No



marque
make Volvo

Modèle
Model S40

Homologation No

ST 32

Extension No

02/02V0

PHOTO No

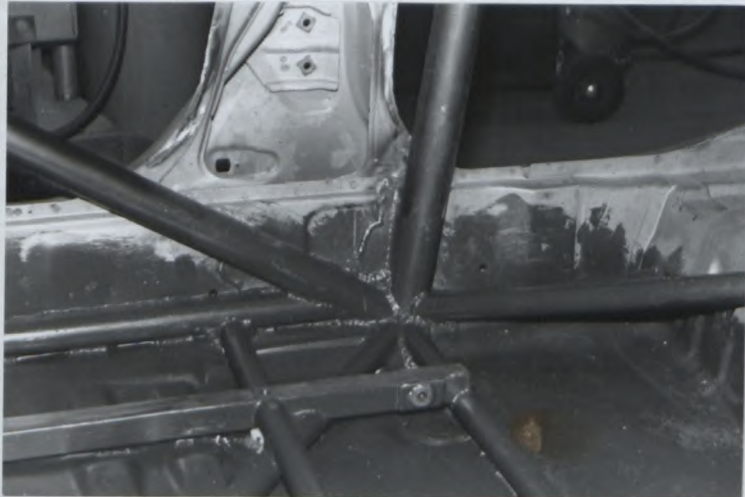

PHOTO No



PHOTO No

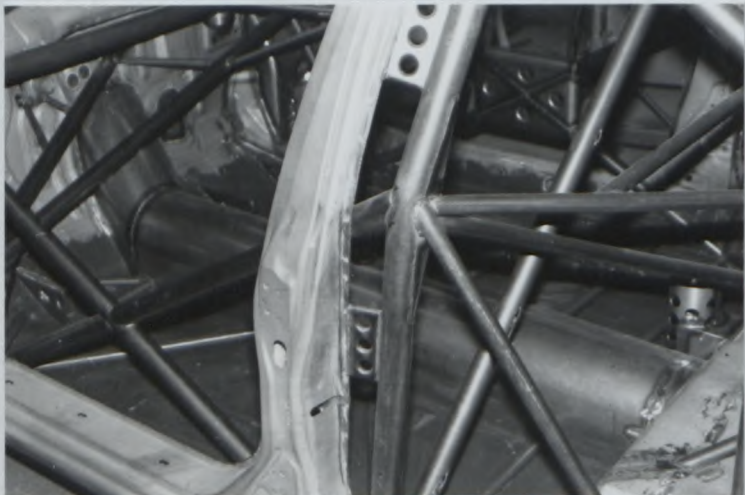

PHOTO No

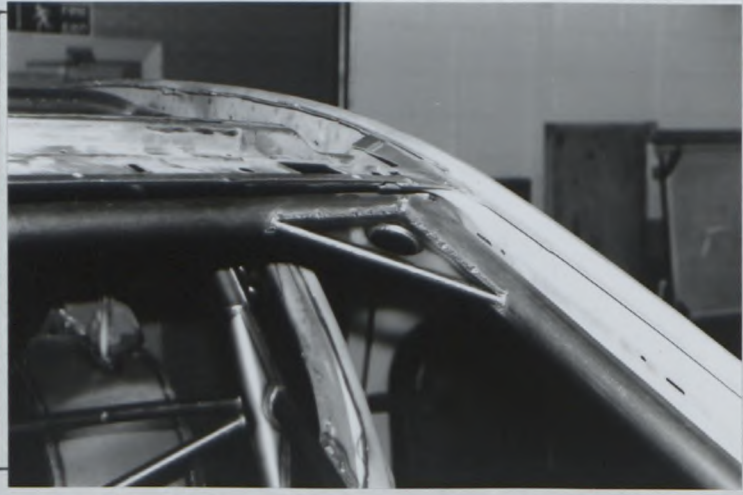
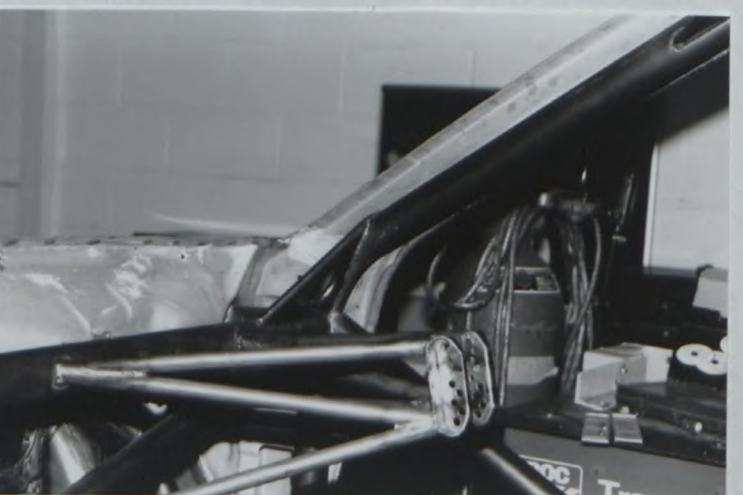

PHOTO No



PHOTO No



Marque / Make Volvo

Modèle / Model S40

Homologation No

ST 32

Extension No

02/02V0

PHOTO No

PHOTO No

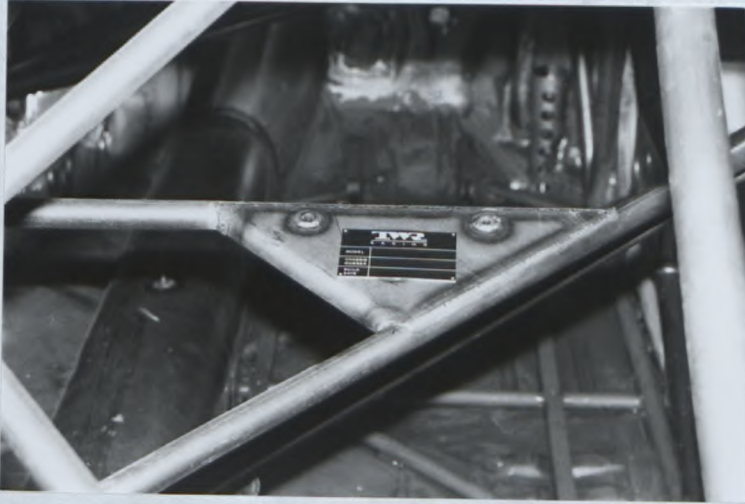

FEDERATION INTERNATIONALE
DE L'AUTOMOBILE

8, place de la Concorde, 75008 Paris

Services Administratifs :

8 bis, rue Boissy d'Anglas, 75008 Paris

SVENSKA BILSPORTFÖRBUNDET
THE SWEDISH AUTOMOBILE SPORT FEDERATION



FEDERATION INTERNATIONALE DE L'AUTOMOBILE

Homologation N°

ST 32

Extension N°

03/03VO

VO

FICHE D'EXTENSION D'HOMOLOGATION POUR DISPOSITIFS AERODYNAMIQUES EN SUPERTOURISME
HOMOLOGATION EXTENSION FORM FOR AERODYNAMIC DEVICES IN SUPER TOURING

Homologation valable à partir du
Homologation valid as from

01 MARS 1997

Véhicule : Constructeur
Vehicle: Manufacturer

Volvo car corp.

Modèle et type
Model and type

VOLVO S40

A) Voiture vue de 3/4 avant
Car seen from 3/4 front



B) Voiture vue de 3/4 arrière
Car seen from 3/4 rear



9. CARROSSERIE / BODYWORK

XVI) DISPOSITIF AVANT DEPOSE ET VU DE FACE AVEC DIMENSIONS DES OUVERTURES :
DISMOUNTED FRONT DEVICE SEEN FROM FRONT WITH DIMENSIONS OF OPENINGS:

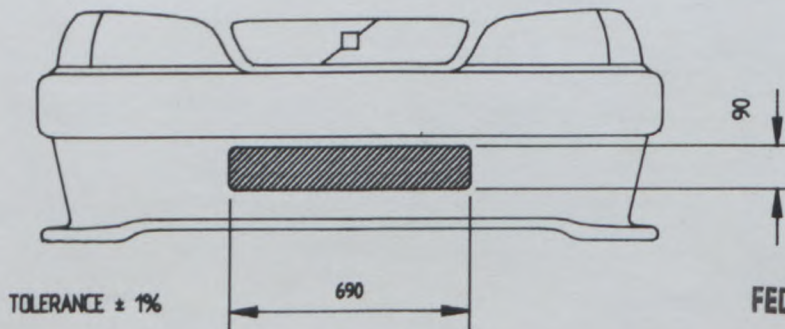

FEDERATION INTERNATIONALE DE L'AUTOMOBILE

8, place de la Concorde, 75008 Paris

Services Administratifs :

8 bis, rue Boissy d'Anglas, 75008 Paris

Volvo

Marque
Make

S40

Modèle
Model

Homologation N°

ST 32

Extension N°

03/03V0

XVIII) DISPOSITIF AVANT DEPOSE ET VU DE COTE AVEC DIMENSIONS DES OUVERTURES :
DISMOUNTED FRONT DEVICE IN SIDE VIEW WITH DIMENSIONS OF OPENINGS:

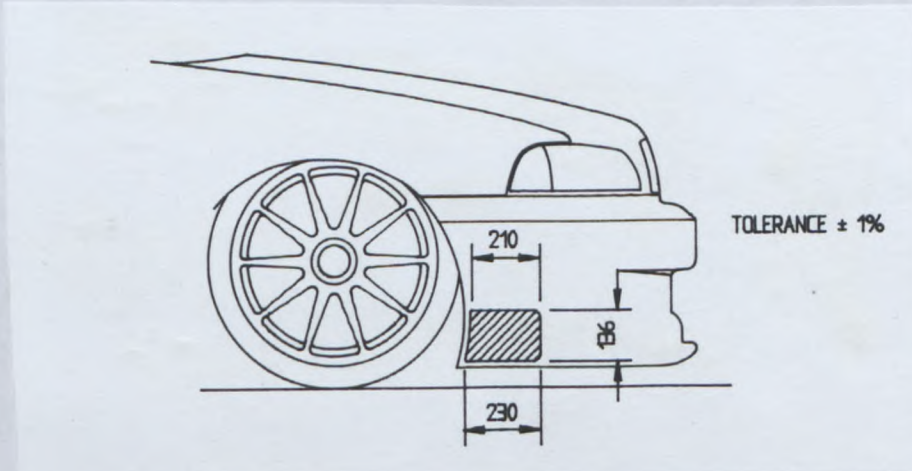

XXIII) DISPOSITIF AVANT EN PLACE ET VU DE FACE :
MOUNTED FRONT DEVICE SEEN FROM FRONT:



XXIV) DISPOSITIF AVANT EN PLACE ET VU DE COTE :
MOUNTED FRONT DEVICE IN SIDE VIEW:



FEDERATION INTERNATIONALE
DE L'AUTOMOBILE

8, place de la Concorde, 75008 Paris
Services Administratifs :
8 bis, rue Boissy d'Anglas, 75008 Paris

XVII) DISPOSITIF ARRIERE EN PLACE
ET VU DE COTE :
MOUNTED REAR DEVICE IN SIDE VIEW:



XIX) SECTION DU DISPOSITIF ARRIERE AU
NIVEAU DE L'AXE LONGITUDINAL DE LA
VOITURE :
SECTION OF REAR DEVICE AT CAR'S
CENTERLINE LEVEL:

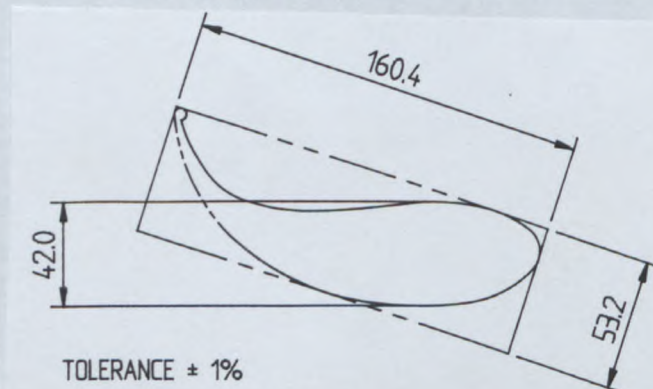

XX) DISPOSITIF ARRIERE EN PLACE ET VU DE DESSUS :
MOUNTED REAR DEVICE SEEN FROM ABOVE:



XXI) DISPOSITIF ARRIERE DEPOSE ET
VU DE COTE :
DISMOUNTED REAR DEVICE IN SIDE VIEW:

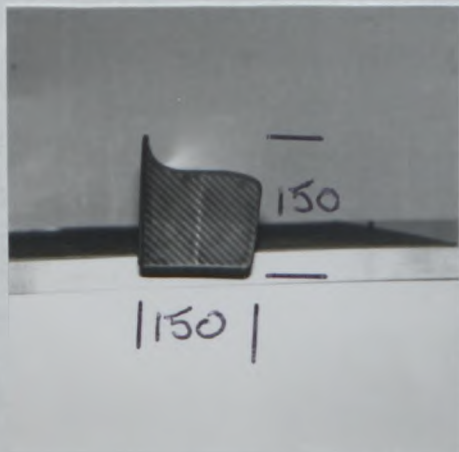

**FEDERATION INTERNATIONALE
DE L'AUTOMOBILE**

8, place de la Concorde, 75008 Paris

Services Administratifs :

8 bis. rue Boissy d'Anglas, 75008 Paris

Volvo

S40

Marque
Make

Modèle
Model

Homologation N°

ST 32

Extension N°

03/03VO

XXII) DISPOSITIF ARRIERE DEPOSE ET VU DE DESSUS :
DISMOUNTED REAR DEVICE SEEN FROM ABOVE:



TOLERANCES: ±1%

902. Extérieur : p) Angle entre dispositif arrière et carrosserie 23°5' ±1°
Exterior: Angle between rear device and bodywork



INFORMATIONS COMPLEMENTAIRES / COMPLEMENTARY INFORMATION :

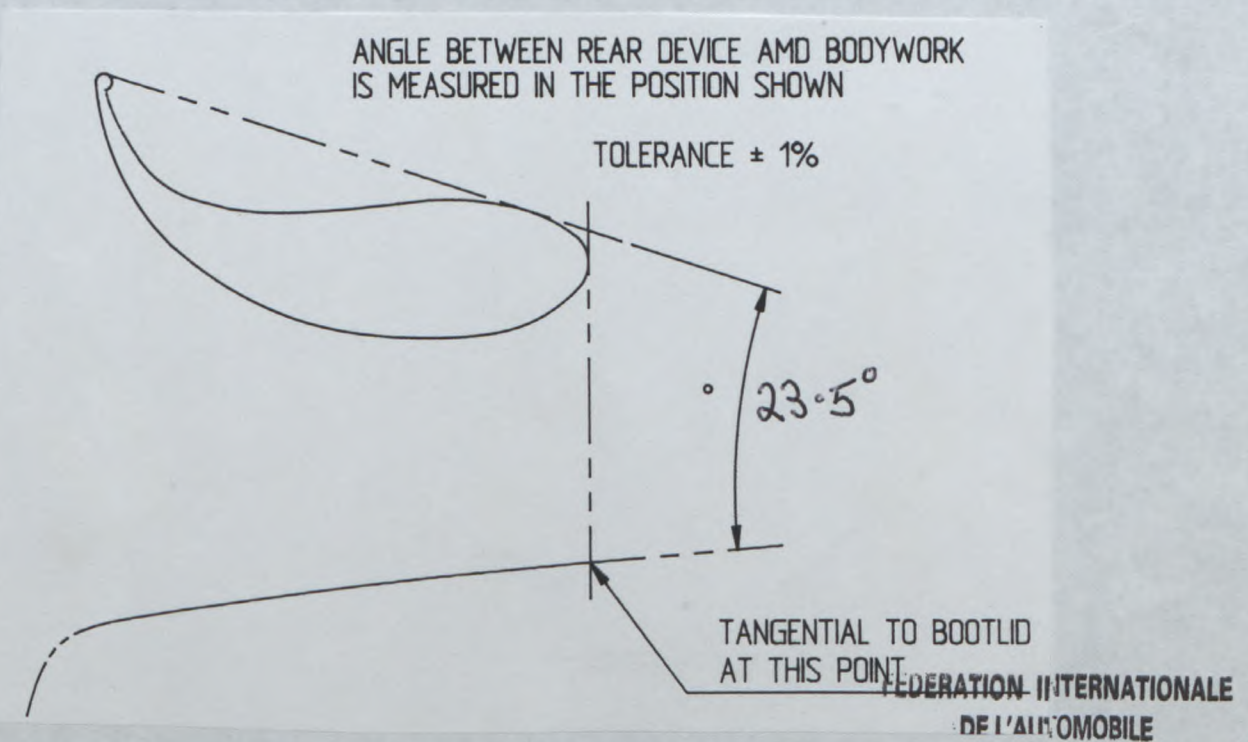

8, place de la Concorde, 75008 Paris

Services Administratifs :

8 bis, rue Boissy d'Anglas, 75008 Paris



FEDERATION INTERNATIONALE DE L'AUTOMOBILE

Homologation No

ST 32

Groupe
Group

~~A/B/N/T1~~ / Supertourisme
Supertouring

Extension No

04/04VO

FICHE D'EXTENSION D'HOMOLOGATION FORM OF HOMOLOGATION EXTENSION

- ES Evolution sportive du type / Sporting evolution of the
- ET Evolution normale du type / Normal evolution of the
- VF Variante de fourniture / Supply variant
- VO Variante option / Option variant
- ER Erratum / Erratum

Véhicule: Constructeur
Vehicle: Manufactureur

VOLVO CAR CORPORATION

Modèle et type
Model and type

VOLVO S40

Homologation valable à partir du
Homologation valid as from

01 JUL. 1997

Page ou ext. Page or ext.	Article Article	Description Description
		<p>MODIFICATIONS TO THE EXHAUST TUNNEL</p>

Q PA - FC - 1990 - 010.04.FB.11.94

FEDERATION INTERNATIONALE DE L'AUTOMOBILE
8, place de la Concorde, 75008 Paris
Services Administratifs :
8 bis, rue Boissv d'Anglas, 75008 Paris



FEDERATION INTERNATIONALE DE L'AUTOMOBILE

Homologation N°

ST 32

Extension N°

05/05 VO

Group **A/B/N/ST**

FICHE D'EXTENSION D'HOMOLOGATION FOR OF HOMOLOGATION EXTENSION

- ES Evolution sportive du type / Sporting evolution of the type
- ET Evolution normale du type / Normal evolution of the type
- VF Variante de fourniture / Supply variant
- VO Variante option / Option variant
- ER Erratum / Erratum

Véhicule : Constructeur VOLVO CAR CORPORATION
Vehicle : Manufacturer

Modèle et type VOLVO S40
Model and type

Homologation valable à partir du **01 MARS 1998**
Homologation valid as from

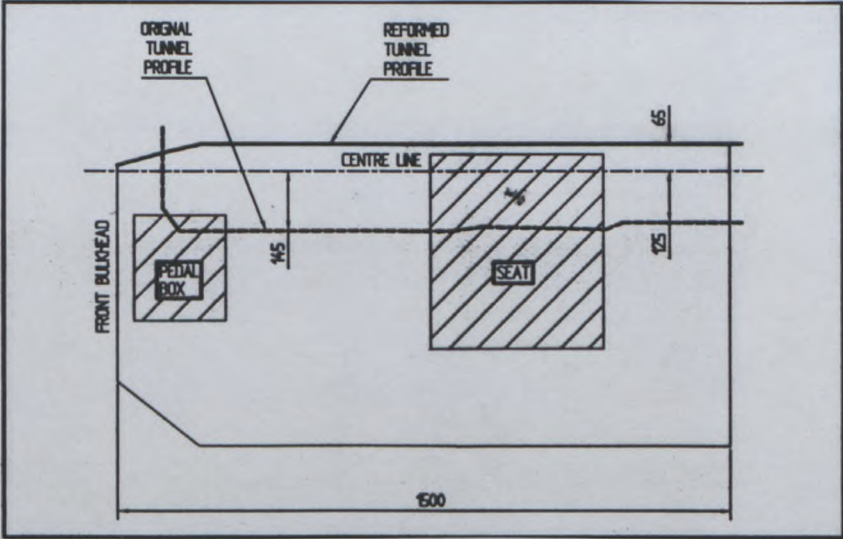
Page or ext.	Article	Description
		<p>MODIFICATIONS TO EXHAUST TUNNEL</p> 

FEDERATION INTERNATIONALE DE L'AUTOMOBILE

8, place de la Concorde, 75008 Paris
Services Administratifs :
8 bis, rue Boissy d'Anglas, 75008 Paris

SVENSKA BILSPORTFÖRBUNDET
THE SWEDISH AUTOMOBILE-SPORT FEDERATION



FEDERATION INTERNATIONALE DE L'AUTOMOBILE

Homologation N°

ST 32

Extension N°

05/05 VO

Group ~~A/B/N~~/ST

FICHE D'EXTENSION D'HOMOLOGATION FOR OF HOMOLOGATION EXTENSION

- ES Evolution sportive du type / Sporting evolution of the type
ET Evolution normale du type / Normal evolution of the type
VF Variante de fourniture / Supply variant
[X] VO Variante option / Option variant
ER Eratum / Erratum

Vehicule : Constructeur VOLVO CAR CORPORATION
Vehicle : Manufacturer

Modele et type VOLVO S40
Model and type

Homologation valable a partir du
Homologation valid as from

Table with 3 columns: Page or ext., Article, Description. Contains a technical drawing of a car chassis in the Description column.

FEDERATION INTERNATIONALE DE L'AUTOMOBILE

8, place de la Concorde, 75008 Paris
Services Administratifs :
8 bis, rue Boissy d'Anglas, 75008 Paris

Marque
Make VOLVO

Modèle
Model S40

Homologation N°

ST 32

Extension N°

05/05 VO

PHOTO N°

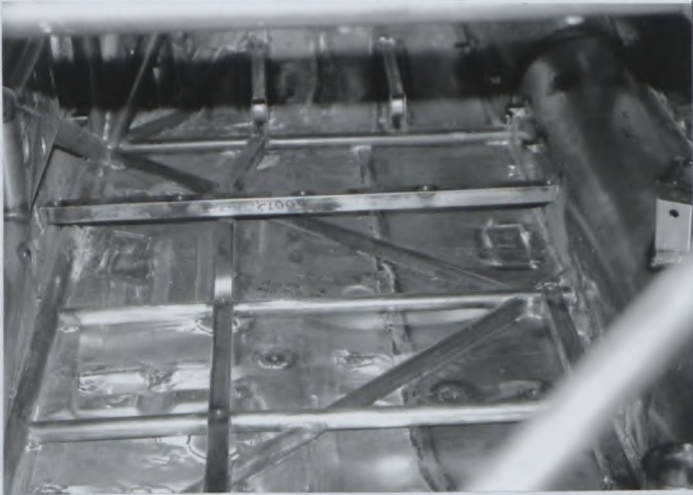

PHOTO N°



PHOTO N°

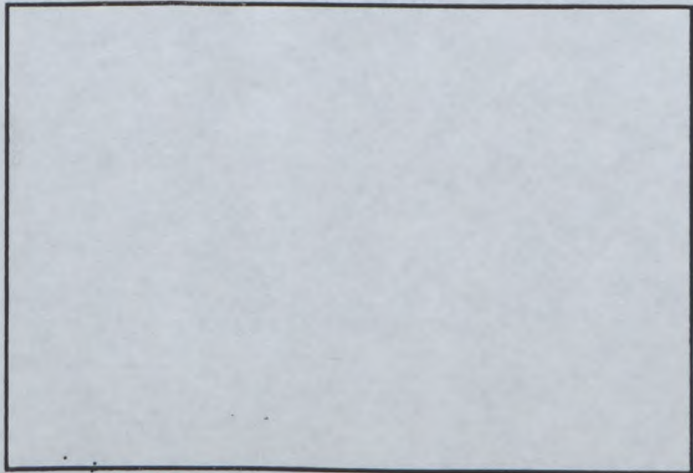

PHOTO N°

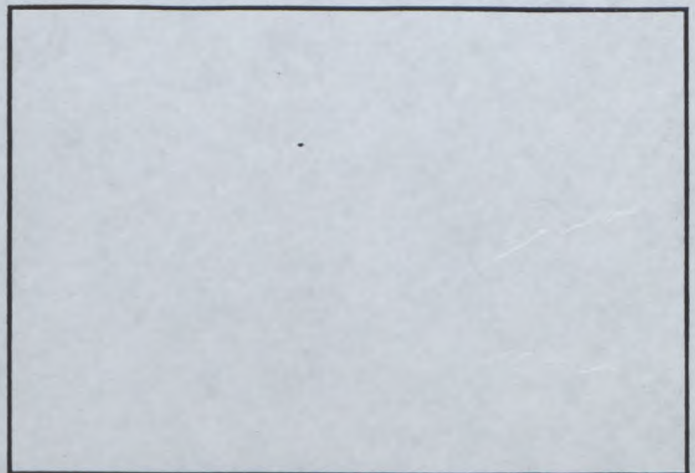

PHOTO N°

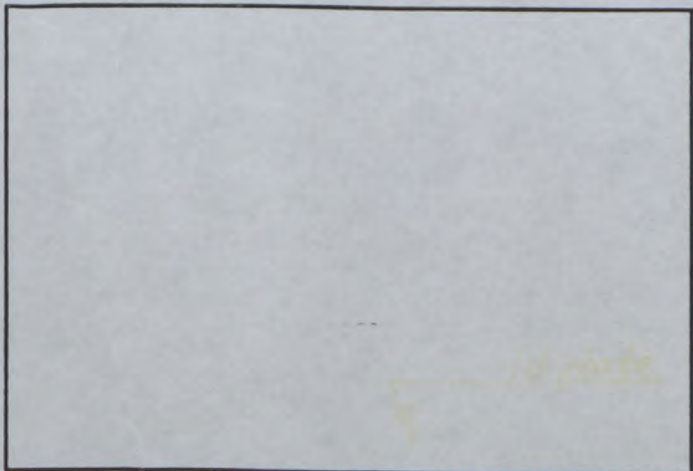
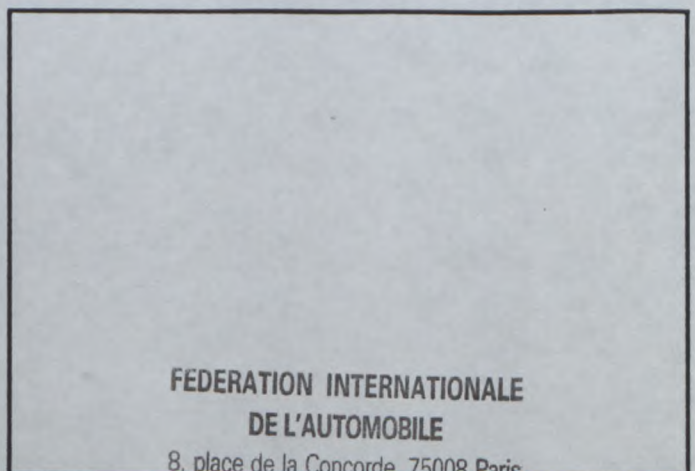

PHOTO N°



FEDERATION INTERNATIONALE
DE L'AUTOMOBILE

8, place de la Concorde, 75008 Paris

Services Administratifs :

8 bis, rue Boissy d'Anglas, 75008 Paris



FEDERATION INTERNATIONALE DE L'AUTOMOBILE

Homologation N°

ST 32

Groupe ~~A/B/N~~ / **ST**
Group

Extension N°

06/06VO

FICHE D'EXTENSION D'HOMOLOGATION POUR ARMATURE DE SECURITE FORM OF HOMOLOGATION EXTENSION FOR SAFETY CAGE

X **VO** Variante option / Option variant

Véhicule : Constructeur VOLVO CAR CORPORATION
Vehicle : Manufacturer

Modèle et type VOLVO S40
Model and type

Homologation valable à partir du 01 MARS 1998
Homologation valid as from

	Arceau principal Main rollbar	Entretoise longitudinale Longitudinal strut	Entretoise diagonale Diagonal strut	Arceau avant Front rollbar
Matériau Material	STEEL (T45)	STEEL (T45)	STEEL (T45)	STEEL (T45)
Diamètre extérieur Exterior diameter	44.4 mm	44.4 mm	38.1 mm	44.4 mm
Epaisseur de paroi Wall thickness	1.2 mm	1.2 mm	0.9 mm	1.2 mm
Limite élastique Elastic limit	62 daN/mm ²	62 daN/mm ²	62 daN/mm ²	62 daN/mm ²
Résistance à la traction Tensile strength	70-90 daN/mm ²	70-90 daN/mm ²	79-90 daN/mm ²	79-90 daN/mm ²

Fabricant de l'armature TWR RACING LTD
Structure-manufacturer

Poids total y compris les fixations 42 kg
Total weight including fixations

Arceau soudé
Welded rollbar

oui / yes non / no

Armature complète hors de la voiture
Complete structure outside the car

(Indiquer par une flèche la position de la plaque d'identification)
(Indicate the position of the identification plate with an arrow)

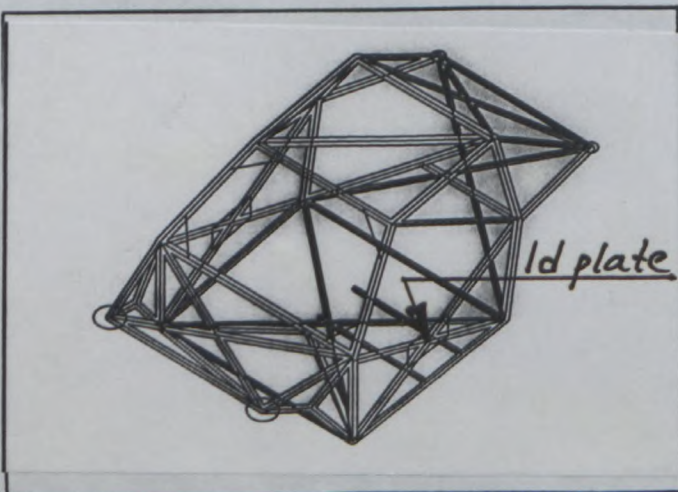

Nous attestons que la présente armature de sécurité répond aux dispositions de l'Annexe J de la FIA, en particulier en ce qui concerne ses implantations, ses connexions, et ses résistances aux contraintes.

We certify that the present safety structure complies with the conditions of the FIA Appendix J, in particular with regard to its attachments, its connections, and its stress resistances.

Hans Gustavsson

8, place de la Concorde, 75008 Paris
Services Administratifs :

Nom et signature du représentant du constructeur du véhicule
Name and signature of the car manufacturer representative

[Handwritten signature]

Marque
Make VOLVO

Modèle
Model S40

ST 32

Extension N°

06/06VO

PHOTO N°

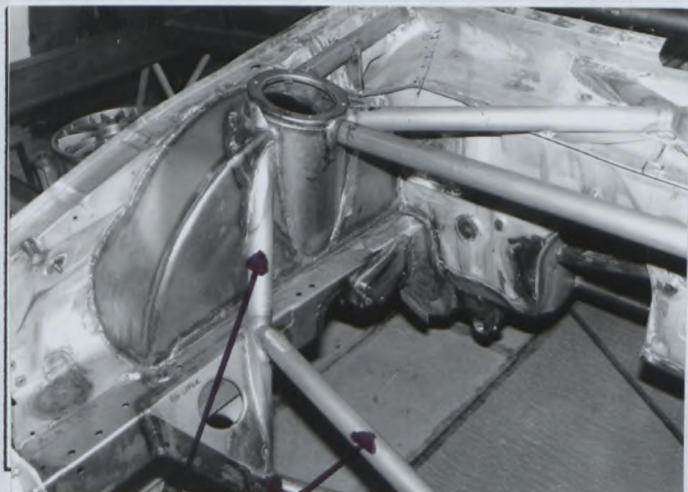

Engine mountings

PHOTO N°

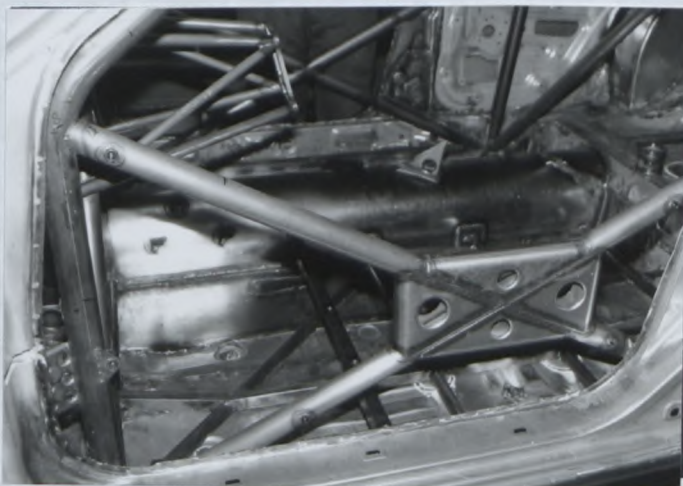

PHOTO N°

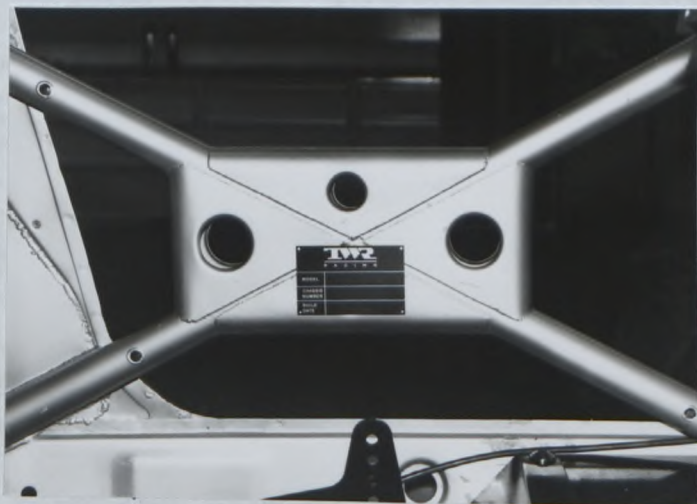

PHOTO N°

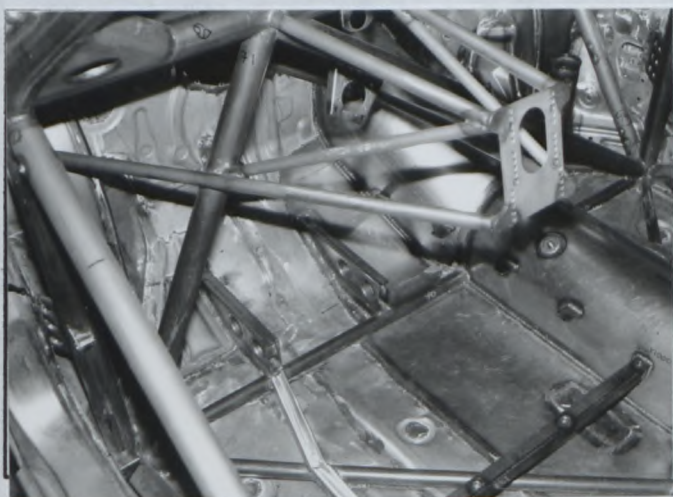
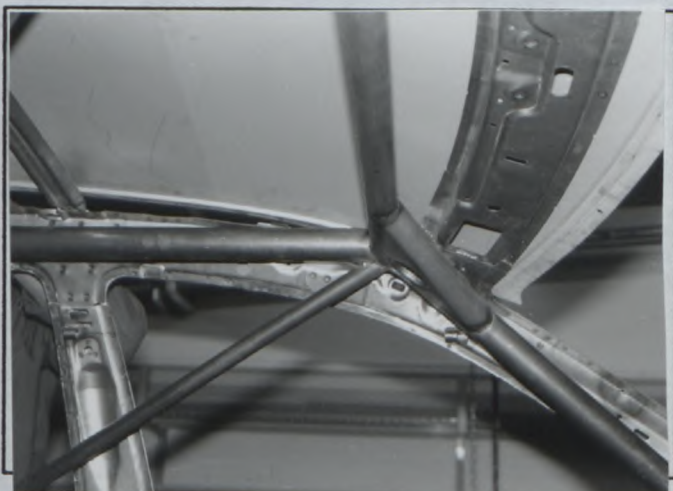

PHOTO N°



PHOTO N°



FEDERATION INTERNATIONALE
DE L'AUTOMOBILE

8, place de la Concorde, 75008 Paris

Services Administratifs :

8 bis, rue Boissy d'Anglas, 75008 Paris

Margue Make VOLVO Modèle Model S40

ST 32

Extension N° 06/06V0

PHOTO N°

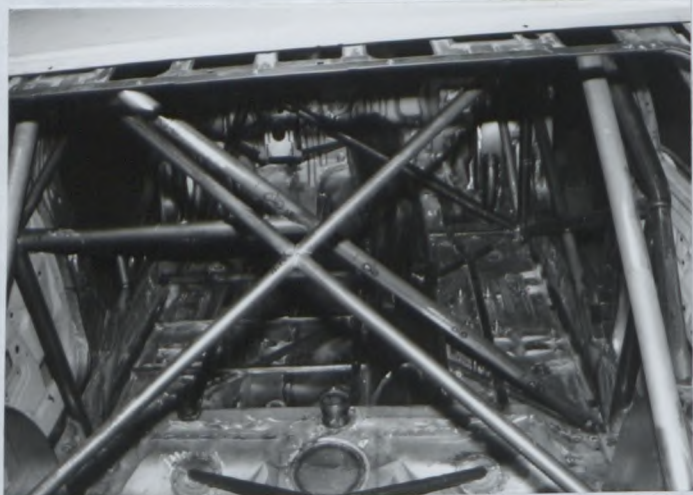

PHOTO N°

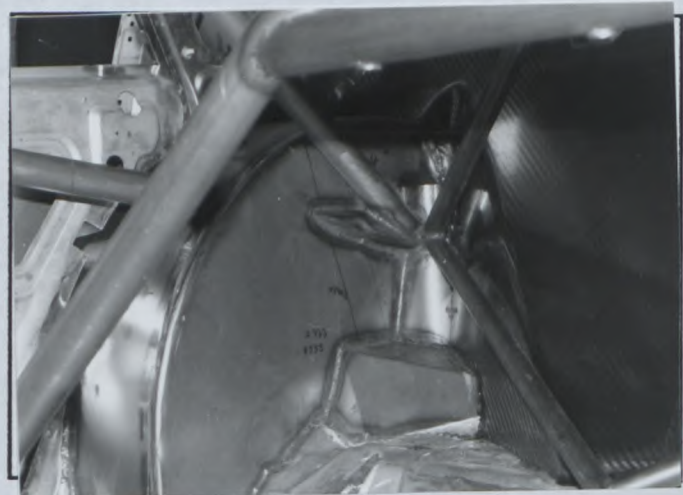

PHOTO N°

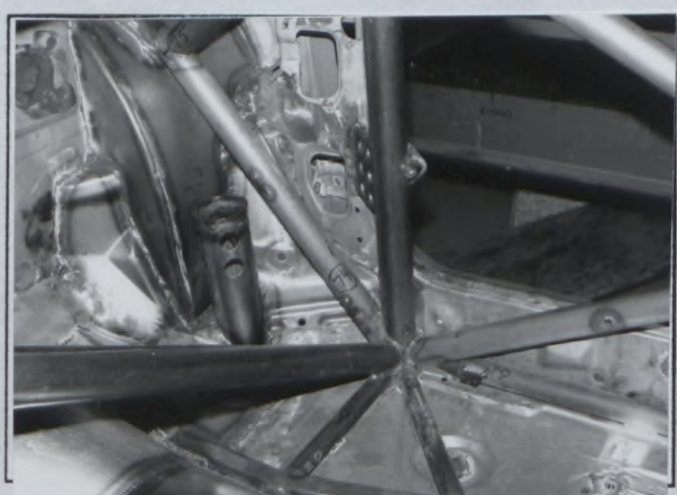

PHOTO N°

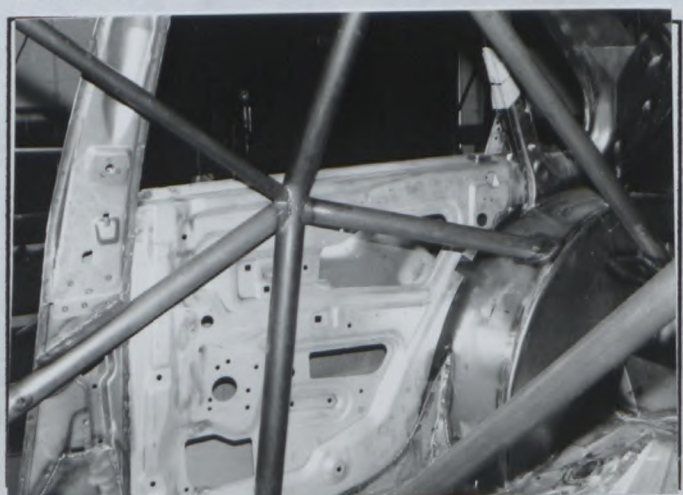

PHOTO N°

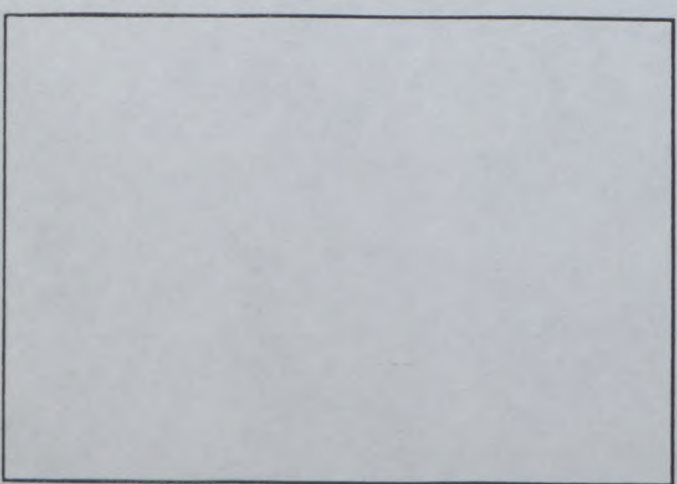
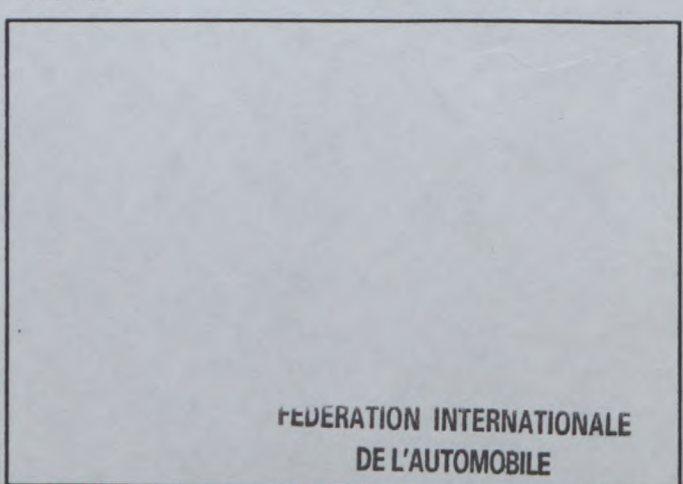

PHOTO N°



FEDERATION INTERNATIONALE DE L'AUTOMOBILE

8, place de la Concorde, 75008 Paris

Services Administratifs :

8 bis, rue Boissy d'Anglas, 75008 Paris



FEDERATION INTERNATIONALE DE L'AUTOMOBILE

Homologation N°

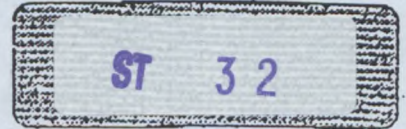

VO

Extension N°

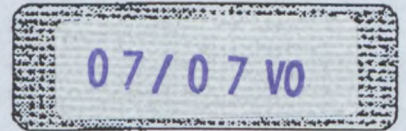

FICHE D'EXTENSION D'HOMOLOGATION POUR DISPOSITIFS AERODYNAMIQUES EN SUPERTOURISME
HOMOLOGATION EXTENSION FORM FOR AERODYNAMIC DEVICES IN SUPER TOURING

Homologation valable à partir du
Homologation valid as from

01 MARS 1998

A) Voiture vue de 3/4 avant
Car seen from 3/4 front



B) Voiture vue de 3/4 arrière
Car seen from 3/4 rear



9. CARROSSERIE / BODYWORK

XVI) DISPOSITIF AVANT DEPOSE ET VU DE FACE AVEC DIMENSIONS DES OUVERTURES :
DISMOUNTED FRONT DEVICE SEEN FROM FRONT WITH DIMENSIONS OF OPENINGS:

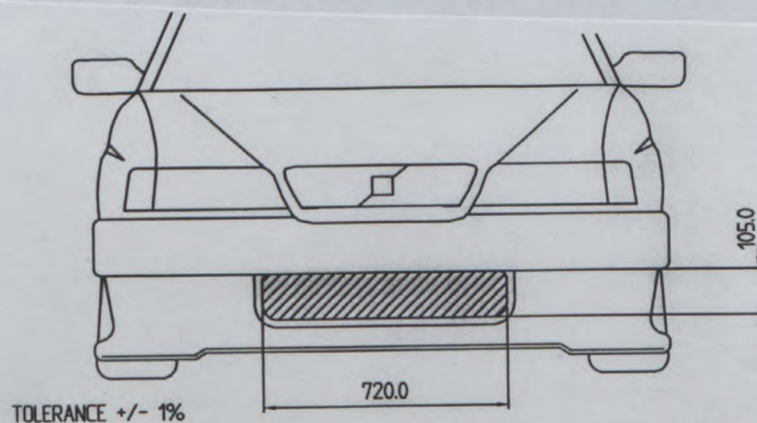

[Signature]

FEDERATION INTERNATIONALE DE L'AUTOMOBILE

8, place de la Concorde, 75008 Paris

Services Administratifs :

8 bis, rue Boissy d'Anglas, 75008 Paris

Marque
Make

Volvo

Modèle
Model

S40

ST 32

07/07 VO

XVIII) DISPOSITIF AVANT DEPOSE ET VU DE COTE AVEC DIMENSIONS DES OUVERTURES :
DISMOUNTED FRONT DEVICE IN SIDE VIEW WITH DIMENSIONS OF OPENINGS:

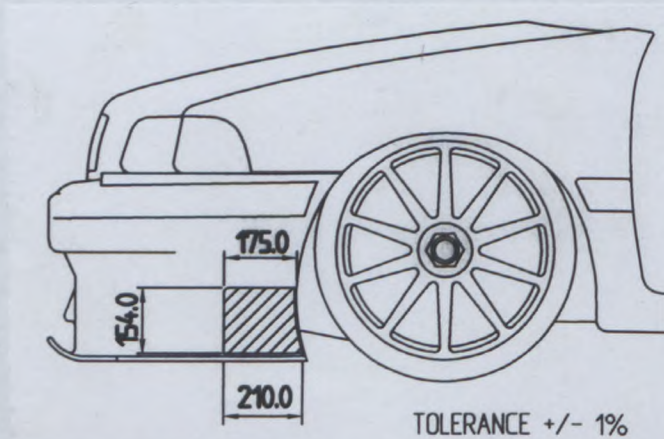

XXIII) DISPOSITIF AVANT EN PLACE ET VU DE FACE :
MOUNTED FRONT DEVICE SEEN FROM FRONT:



XXIV) DISPOSITIF AVANT EN PLACE ET VU DE COTE :
MOUNTED FRONT DEVICE IN SIDE VIEW:



FEDERATION INTERNATIONALE
DE L'AUTOMOBILE

8, place de la Concorde, 75008 Paris

Services Administratifs :

2 bis rue Boissy d'Anglas, 75008 Paris

Marque
Make

Volvo

Modèle
Model

S40

ST 32

07/07 VO

XVII) DISPOSITIF ARRIERE EN PLACE
ET VU DE COTE :
MOUNTED REAR DEVICE IN SIDE VIEW:

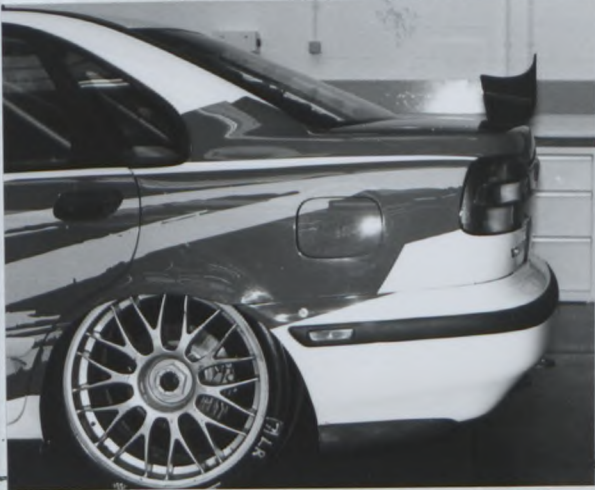

XIX) SECTION DU DISPOSITIF ARRIERE AU
NIVEAU DE L'AXE LONGITUDINAL DE LA
VOITURE :
SECTION OF REAR DEVICE AT CAR'S
CENTERLINE LEVEL:

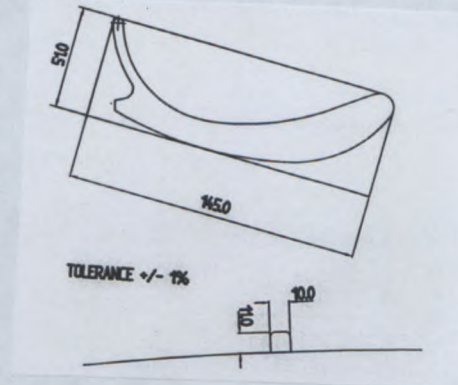

XX) DISPOSITIF ARRIERE EN PLACE ET VU DE DESSUS :
MOUNTED REAR DEVICE SEEN FROM ABOVE:

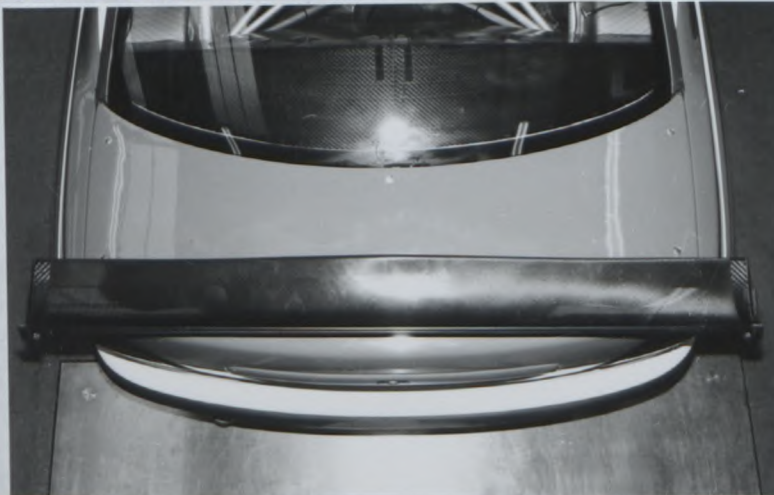

XXI) DISPOSITIF ARRIERE DEPOSE ET
VU DE COTE :
DISMOUNTED REAR DEVICE IN SIDE VIEW:

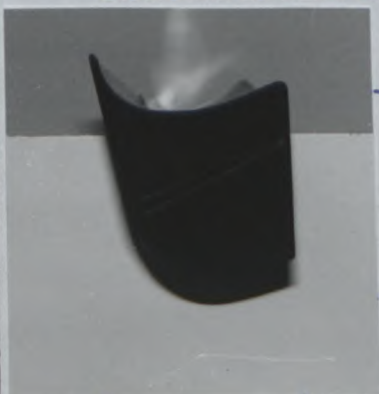

150

150

FEDERATION INTERNATIONALE
DE L'AUTOMOBILE

8, place de la Concorde, 75008 Paris

Services Administratifs :

8 bis, rue Boissy d'Anglas, 75008 Paris

Marque
Make

Volvo

Modèle
Model

S40

ST 32

07/07 VO

XXII) DISPOSITIF ARRIERE DEPOSE ET VU DE DESSUS :
DISMOUNTED REAR DEVICE SEEN FROM ABOVE:

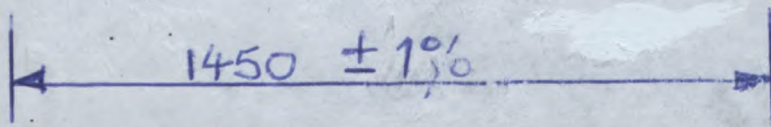

902. Extérieur :
Exterior:

p) Angle entre dispositif arrière et carrosserie
Angle between rear device and bodywork

$16^\circ \pm 1^\circ$



INFORMATIONS COMPLEMENTAIRES / COMPLEMENTARY INFORMATION :

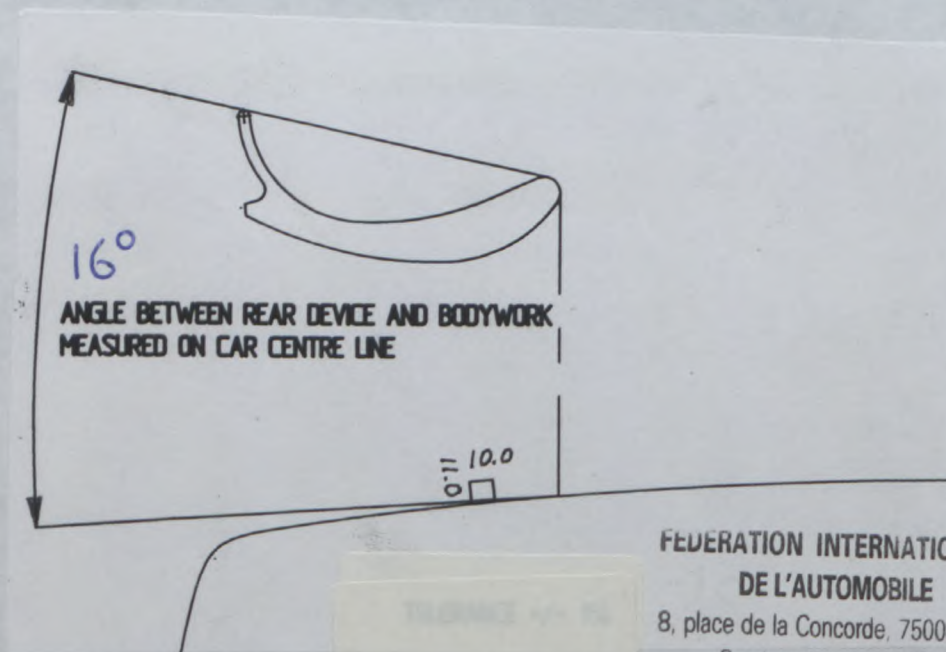

FEDERATION INTERNATIONALE
DE L'AUTOMOBILE

8, place de la Concorde, 75008 Paris

Services Administratifs :

8 bis, rue Boissy d'Anglas, 75008 Paris



FEDERATION INTERNATIONALE DE L'AUTOMOBILE

Homologation No

ST-32

Groupe / Group

~~A/B/N/T1~~ / Supertourisme / Supertouring

Extension No

08 / 01 ER

FICHE D'EXTENSION D'HOMOLOGATION / FORM OF HOMOLOGATION EXTENSION

- ES Evolution sportive du type / Sporting evolution of the
ET Evolution normale du type / Normal evolution of the
VF Variante de fourniture / Supply variant
VO Variante option / Option variant
ER Erratum / Erratum

Vehicule: Constructeur / Vehicle: Manufactureur Volvo Car Corporation
Modele et type / Model and type Volvo S40

Homologation valable a partir du / Homologation valid as from 01 AVR. 1998

Table with 3 columns: Page ou ext. / Page or ext., Article / Article, Description / Description. Row 1: 2, 204a), Was 1683 is now 1688. Row 2: 1, New photos A and B.

The original design... production start... of 1688 mm. Internal production... to be adjusted.

FA - FC - 1990 - 01004.FB.11.94

FIA logo and address: FEDERATION INTERNATIONALE DE L'AUTOMOBILE, 8, place de la Concorde, 75008 Paris

SVENSKA BILSPORTFORBUNDET / THE SWEDISH AUTOMOBILE SPORT FEDERATION

Marque Volvo
Make _____

Modèle S40
Model _____

Homologation No

ST 32

Extension No

08 / 01 ER

PHOTO No



PHOTO No



PHOTO No

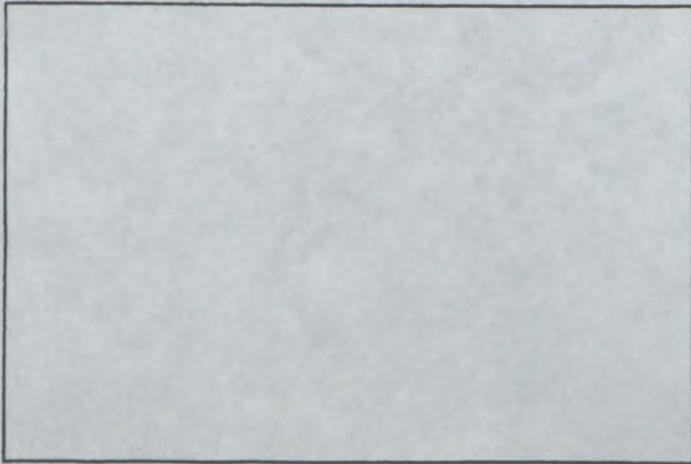

PHOTO No

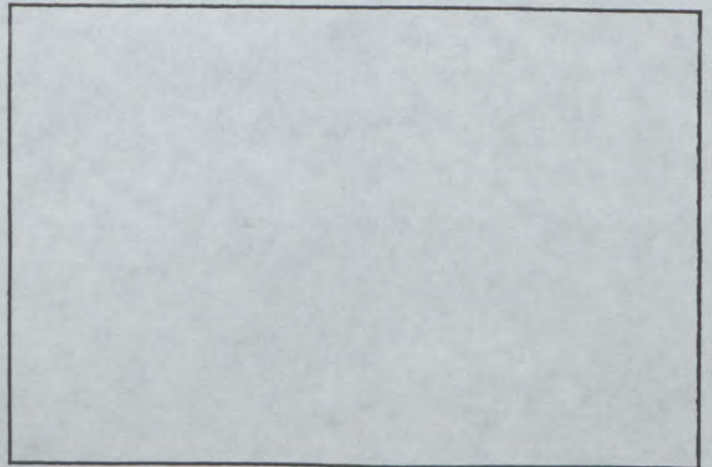

PHOTO No

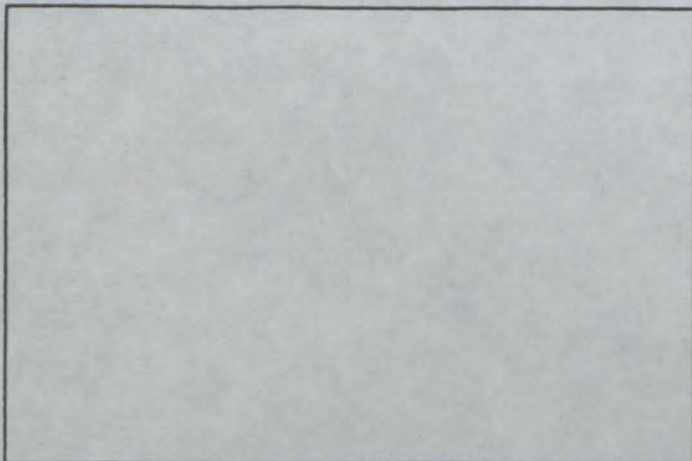
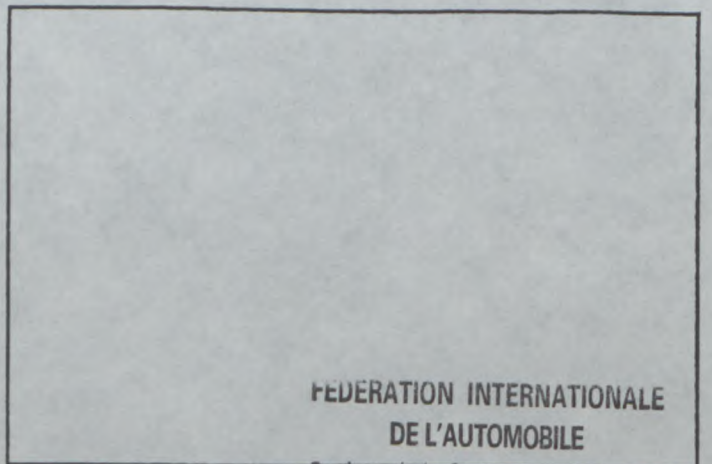

PHOTO No



**FEDERATION INTERNATIONALE
DE L'AUTOMOBILE**

8, place de la Concorde, 75008 Paris

Services Administratifs :

9 bis rue Boissy d'Anglas, 75008 Paris