



FEDERATION INTERNATIONALE DE L' AUTOMOBILE

Homologation No

ST - - 019

Groupe Group SUPERTOURISME SUPERTOURING

FICHE D'HOMOLOGATION CONFORME A L'ANNEXE J DU CODE SPORTIF INTERNATIONAL HOMOLOGATION FORM IN ACCORDANCE WITH APPENDIX J OF THE INTERNATIONAL SPORTING CODE

Homologation valable à partir du 1 APRIL 1995 Homologation valid as from

A) Voiture vue de 3/4 avant Car seen from 3/4 front



B) Voiture vue de 3/4 arrière Car seen from 3/4 rear



1. GENERALITES / GENERAL

101. Constructeur FORD MOTOR COMPANY LIMITED Manufacturer

102. Dénomination(s) commerciale(s) - Modèle et type MONDEO - 4 DOOR Commercial name(s) - Model and type

104. Mode de construction : a) Mode : séparés / Type of car construction : Type : separate / monocoque / unitary construction

b) Matériau du châssis / coque STEEL SHEET WITH PLASTIC BODY MOULDINGS Material of chassis / bodyshell

105. Nombre de volumes 3 Number of volumes

106. Nombre de places 5 Number of places

Handwritten signature

FEDERATION INTERNATIONALE DE L'AUTOMOBILE 8, place de la Concorde, 75008 Paris Services Administratifs : P bis rue Boissy d'Angles, 75008 Paris

Marque  
Make **FORD**

Modèle  
Model **MONDEO - 4 DOOR**

Homologation No

**ST - - 019**

A9) Coque vue de 3/4 avant, sans portes, capots, etc.  
Bodyshell seen from 3/4 front without doors, lids, etc.



A10) Coque vue de 3/4 arrière, sans portes, capots, etc.  
Bodywork seen from 3/4 rear without doors, lids, etc.



## 2. DIMENSIONS, POIDS / DIMENSIONS, WEIGHT

202. Longueur hors-tout **4485** mm +/- 1 %  
Overall length

203. Largeur hors-tout **1754** mm +/- 1 %  
Overall width

Endroit de mesure **AT CENTRE LINE OF REAR AXLE**  
Where measured

204. Largeur de carrosserie **1732** mm +/- 1 %  
Width of bodywork a) A la hauteur de l'axe avant  
At front axle

b) A la hauteur de l'axe arrière **1754** mm +/- 1 %  
At rear axle

206. Empattement **2695** mm +/- 1 %  
Wheelbase

209. Porte-à-faux **850** mm +/- 1 % a) Avant  
Overhang Front b) Arrière **940** mm +/- 1 %  
Rear

210. Distance "G" (volant - paroi de séparation arrière) **1655** mm  
Distance "G" (steering wheel - rear bulkhead)

Marque **FORD**  
Make \_\_\_\_\_

Modèle **MONDEO - 4 DOOR**  
Model \_\_\_\_\_

**ST - - 019**

#### 4. CIRCUIT DE CARBURANT / FUEL CIRCUIT

401. Réservoir : b) Emplacement **UNDER FLOOR, BENEATH REAR SEAT**  
Fuel tank : Location \_\_\_\_\_

#### 6. TRANSMISSION / POWER TRAIN

601. Roues motrices : avant oui    arrière  non  
Driven wheels : front yes    rear  no

603. Boîte de vitesses : a1) Emplacement dans l'empattement        
Gearbox : Location in wheelbase front half

#### XII) CHAÎNE CINÉMATIQUE (4 roues motrices) / KINEMATIC TRAIN (4 wheel drive) :

Marque FORD  
Make \_\_\_\_\_Modèle MONDEO - 4 DOOR  
Model \_\_\_\_\_

ST - - 019

**Modifications nécessaires pour passer d'une version 2 roues motrices (au moins 2500 exemplaires) à une version 4 roues motrices (au moins 2500 exemplaires) / Modifications necessary in order to go from a 2-wheel drive version (at least 2500 cars) to a 4-wheel drive version (at least 2500 cars)**

Marque FORD  
 Make \_\_\_\_\_

Modèle MONDEO - 4 DOOR  
 Model \_\_\_\_\_

**ST - - 019**

**7. SUSPENSION / SUSPENSION**

	Avant / Front	Arrière / Rear				
<b>701. Généralités / General</b>						
a) Type de suspension / Type of suspension	MACPHERSON	MULTI LINK				
<b>702. Ressorts hélicoïdaux / Helicoïdal springs</b>	<table border="1"> <tr> <td>oui / yes</td> <td><del>non</del> / <del>no</del></td> </tr> </table>	oui / yes	<del>non</del> / <del>no</del>	<table border="1"> <tr> <td>oui / yes</td> <td><del>non</del> / <del>no</del></td> </tr> </table>	oui / yes	<del>non</del> / <del>no</del>
oui / yes	<del>non</del> / <del>no</del>					
oui / yes	<del>non</del> / <del>no</del>					
<b>703. Ressorts à lames / Leaf springs</b>	<table border="1"> <tr> <td><del>oui</del> / <del>yes</del></td> <td>non / no</td> </tr> </table>	<del>oui</del> / <del>yes</del>	non / no	<table border="1"> <tr> <td><del>oui</del> / <del>yes</del></td> <td>non / no</td> </tr> </table>	<del>oui</del> / <del>yes</del>	non / no
<del>oui</del> / <del>yes</del>	non / no					
<del>oui</del> / <del>yes</del>	non / no					
<b>704. Barres de torsion / Torsion bars</b>	<table border="1"> <tr> <td><del>oui</del> / <del>yes</del></td> <td>non / no</td> </tr> </table>	<del>oui</del> / <del>yes</del>	non / no	<table border="1"> <tr> <td><del>oui</del> / <del>yes</del></td> <td>non / no</td> </tr> </table>	<del>oui</del> / <del>yes</del>	non / no
<del>oui</del> / <del>yes</del>	non / no					
<del>oui</del> / <del>yes</del>	non / no					

**705. Autre type de suspension : / Other type of suspension :** *Voir description sur fiche additionnelle / See description on additional form*

	Avant / Front	Arrière / Rear
<b>707. Amortisseurs : / Shock absorbers :</b>		
a) Nombre par roue / Number per wheel	<u>1</u>	<u>1</u>

T) Train avant complet déposé / Complete dismantled front axle

U) Train arrière complet déposé / Complete dismantled rear axle

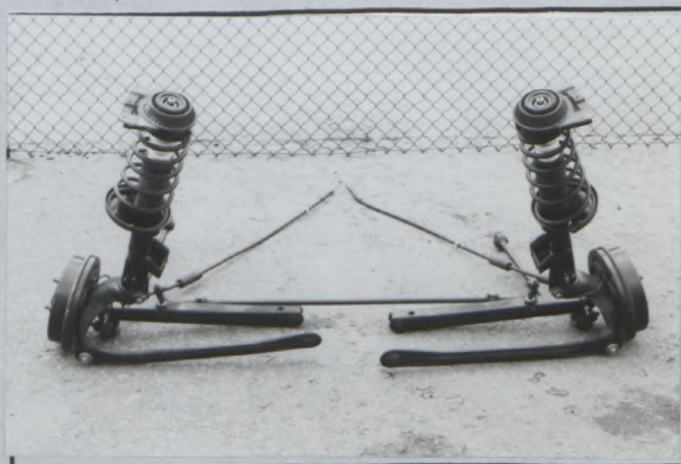
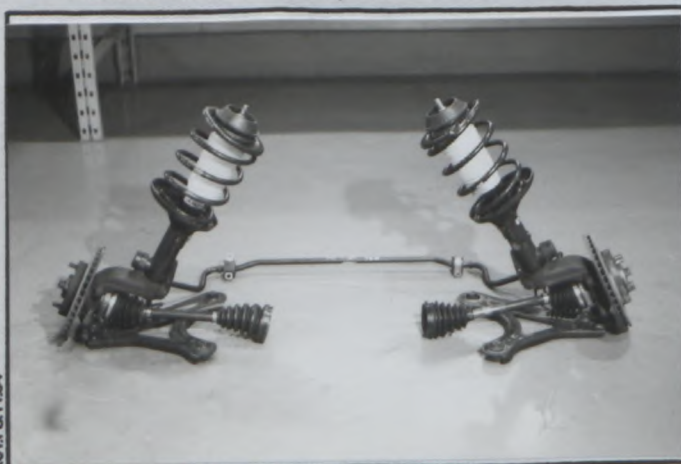

C) RSA - FC - 1934 - 046,01,FB,11,94

**8. TRAIN ROULANT / RUNNING GEAR**

	Avant / Front	Arrière / Rear
<b>804. Direction : / Steering :</b>		
a) Type / Type	RACK & PINION	FEDERATION INTERNATIONALE

DE L'AUTOMOBILE

8, place de la Concorde, 75008 Paris  
 Services Administratifs :  
 8 bis, rue Boissy d'Anglas, 75008 Paris

Marque FORD  
 Make \_\_\_\_\_

Modèle MONDEO - 4 DOOR  
 Model \_\_\_\_\_

**ST - - 019**

## 9. CARROSSERIE / BODYWORK

- X) Tableau de bord  
 Dashboard

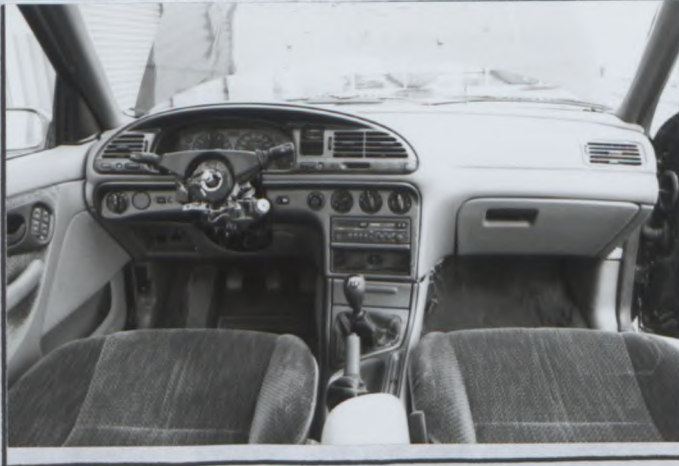

902. Extérieur :  
 Exterior :

a) Nombre de portes 4  
 Number of doors \_\_\_\_\_

b) Hayon  
 Tailgate

oui	<del>NON</del>
yes	<del>NO</del>

c) Matériau des portières  
 Door material

Avant / Front	Arrière / Rear
STEEL	STEEL

d) Matériau du capot avant  
 Front bonnet material

STEEL

e) Matériau du capot arrière / hayon  
 Rear bonnet / tailgate material

STEEL

f) Matériau de la carrosserie  
 Bodywork material

STEEL SHEET WITH PLASTIC MOULDINGS

h) Matériau de lunette arrière  
 Rear window material

GLASS

i) Matériau des glaces de custode  
 Rear quarter window material

k) Matériau des vitres latérales  
 Side window material

Avant / Front	Arrière / Rear
GLASS	GLASS
POLYCARBONATE	POLYCARBONATE

l) Matériau du pare-choc  
 Material of bumper

Marque  
Make

FORD

Modèle  
Model

MONDEO - 4 DOOR

ST - - 019

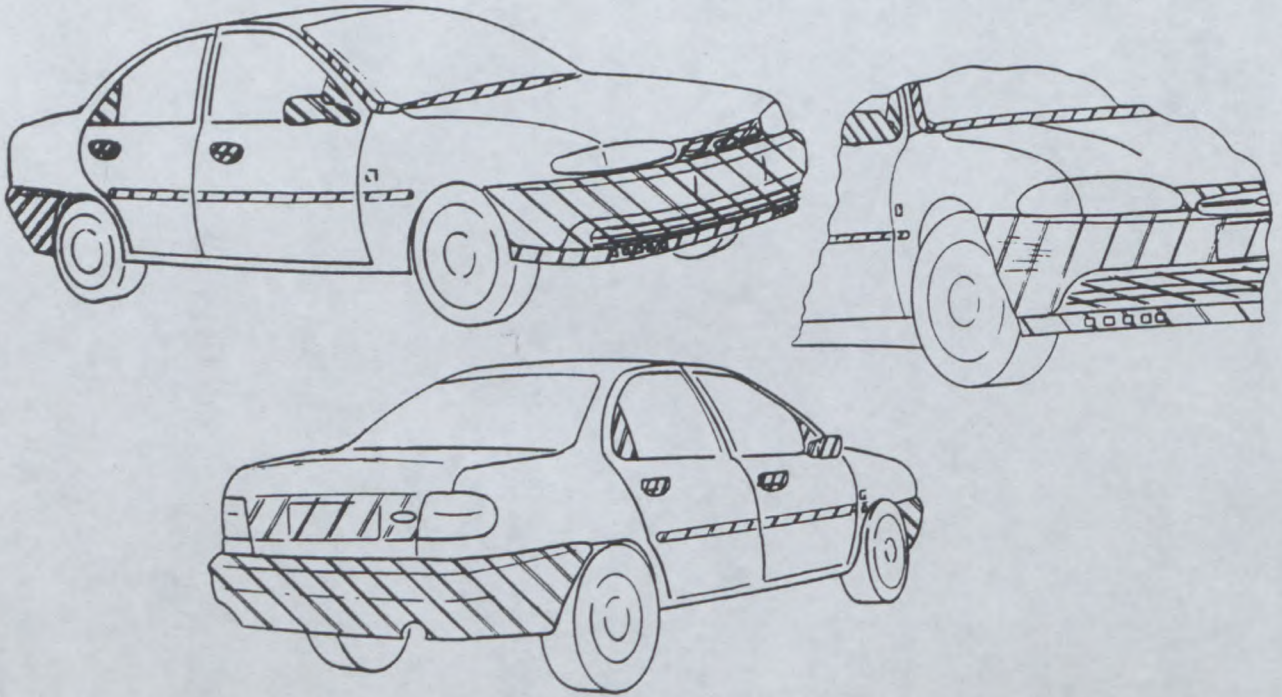
**XIII) PARTIES DE CARROSSERIE SYNTHETIQUES / SYNTHETIC PARTS OF THE BODY :****INFORMATIONS COMPLEMENTAIRES / COMPLEMENTARY INFORMATION :**

Alternative front grille without chrome trim surround.



FEDERATION INTERNATIONALE  
DE L'AUTOMOBILE

8, place de la Concorde, 75008 Paris

Services Administratifs :

8 bis, rue Boissy d'Anglas, 75008 Paris



FEDERATION INTERNATIONALE DE L'AUTOMOBILE

Homologation No  
**ST - - 019**

Groupes  
Group

**Supertourisme**  
**Supertouring**

Extension No

**CERTIFICAT DE DIMENSIONS INTERIEURES**  
**CERTIFICATE FOR INTERIOR DIMENSIONS**

Véhicule: Constructeur FORD Modèle et type MONDEO 4 DOOR  
Vehicle: Manufactureur \_\_\_\_\_ Model and type \_\_\_\_\_

Dimensions intérieures comme définies par le Règlement d'Homologation  
Interior dimensions as defined by the Homologation Regulations

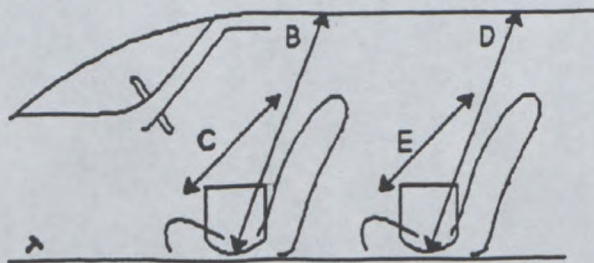

<b>B</b>	(Hauteur sur sièges avant) (Height above front seats)	<u>980</u> mm
<b>C</b>	(Largeur aux sièges avant) (Width at front seats)	<u>1390</u> mm
<b>D</b>	(Hauteur sur sièges arrière) (Height above rear seats)	<u>940</u> mm
<b>E</b>	(Largeur aux sièges arrière) (Width at rear seats)	<u>1410</u> mm

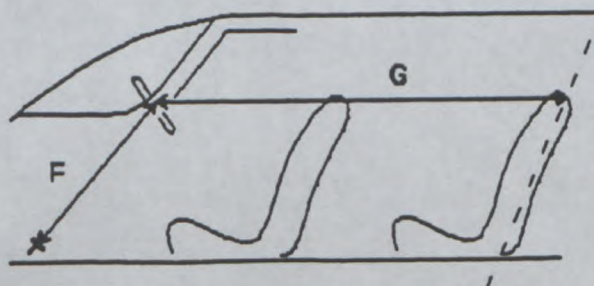

<b>F</b>	(Volant - Pédale de frein) (Steering wheel - Brake pedal)	<u>625</u> mm
<b>G</b>	(Volant - paroi de séparation arrière) (Steering wheel - rear bulkhead)	<u>1655</u> mm
<b>H</b>	<b>H = F + G =</b>	<u>2280</u> mm

CI RA - FC - 1994 - 004.01.FB.11.94





FEDERATION INTERNATIONALE DE L'AUTOMOBILE

Homologation N°

ST - - 019

Extension N°

01/01VO

VO

FICHE D'EXTENSION D'HOMOLOGATION POUR DISPOSITIFS AERODYNAMIQUES EN SUPERTOURISME  
HOMOLOGATION EXTENSION FORM FOR AERODYNAMIC DEVICES IN SUPER TOURING

Homologation valable à partir du  
Homologation valid as from

1 APRIL 1995

A) Voiture vue de 3/4 avant  
Car seen from 3/4 front



B) Voiture vue de 3/4 arrière  
Car seen from 3/4 rear



9. CARROSSERIE / BODYWORK

XVI) DISPOSITIF AVANT DEPOSE ET VU DE FACE AVEC DIMENSIONS DES OUVERTURES :  
DISMOUNTED FRONT DEVICE SEEN FROM FRONT WITH DIMENSIONS OF OPENINGS:

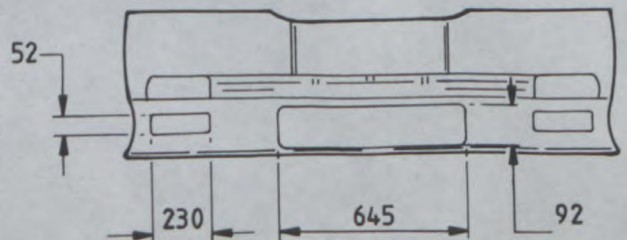

Tolerance +/- 1 %

FEDERATION INTERNATIONALE DE L'AUTOMOBILE

8, place de la Concorde, 75008 Paris

Services Administratifs :

10, rue Boissier d'Angoulême, 75008 Paris

Marque  
Make

FORD

Modèle  
Model

MONDEO 4 DOOR

ST - - 019

01/01V0

XVIII) DISPOSITIF AVANT DEPOSE ET VU DE COTE AVEC DIMENSIONS DES OUVERTURES :  
DISMOUNTED FRONT DEVICE IN SIDE VIEW WITH DIMENSIONS OF OPENINGS:



XXIII) DISPOSITIF AVANT EN PLACE ET VU DE FACE :  
MOUNTED FRONT DEVICE SEEN FROM FRONT:



XXIV) DISPOSITIF AVANT EN PLACE ET VU DE COTE :  
MOUNTED FRONT DEVICE IN SIDE VIEW:



FEDERATION INTERNATIONALE  
DE L'AUTOMOBILE

8, place de la Concorde, 75008 Paris

Services Administratifs :

8 bis, rue Boissy d'Angles 75008 Paris

Marque  
Make

FORD

Modèle  
Model

MONDEO 4 DOOR

ST - - 019

01/01V0

XVII) DISPOSITIF ARRIERE EN PLACE  
ET VU DE COTE :  
MOUNTED REAR DEVICE IN SIDE VIEW:



XIX) SECTION DU DISPOSITIF ARRIERE AU  
NIVEAU DE L'AXE LONGITUDINAL DE LA  
VOITURE :  
SECTION OF REAR DEVICE AT CAR'S  
CENTERLINE LEVEL:

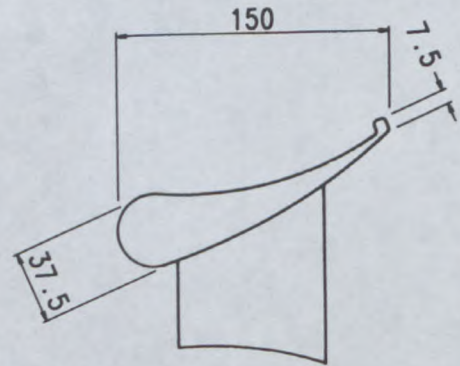

XX) DISPOSITIF ARRIERE EN PLACE ET VU DE DESSUS :  
MOUNTED REAR DEVICE SEEN FROM ABOVE:



XXI) DISPOSITIF ARRIERE DEPOSE ET  
VU DE COTE :  
DISMOUNTED REAR DEVICE IN SIDE VIEW:



FEDERATION INTERNATIONALE  
DE L'AUTOMOBILE

8, place de la Concorde, 75008 Paris

Services Administratifs :

8 bis, rue Boissy d'Anglas, 75008 Paris

Marque  
Make

FORD

Modèle  
Model

MONDEO 4 DOOR

ST - - 019

01/01V0

XXII) DISPOSITIF ARRIERE DEPOSE ET VU DE DESSUS :  
DISMOUNTED REAR DEVICE SEEN FROM ABOVE:

Width = 1372 mm

Tolerance +/- 1 %



902. Extérieur :  
Exterior:

p) Angle entre dispositif arrière et carrosserie  
Angle between rear device and bodywork

$18^{\circ} \pm 1^{\circ}$

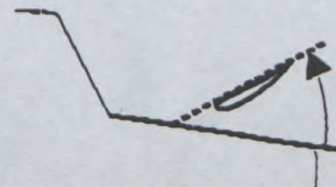

INFORMATIONS COMPLEMENTAIRES / COMPLEMENTARY INFORMATION :



FEDERATION INTERNATIONALE  
DE L'AUTOMOBILE

Homologation No

ST-019

Groupe  
Group

Supertourisme  
Supertouring

Extension No

02/01ER

FICHE D'EXTENSION D'HOMOLOGATION  
FORM OF HOMOLOGATION EXTENSION

- ES Evolution sportive du type / Sporting evolution of the
- ET Evolution normale du type / Normal evolution of the
- VF Variante de fourniture / Supply variant
- VO Variante option / Option variant
- ER Erratum / Erratum

Véhicule: Constructeur FORD Modèle et type MONDEO 4 DOOR  
 Vehicle: Manufactureur \_\_\_\_\_ Model and type \_\_\_\_\_

Homologation valable à partir du 1 July 1995  
 Homologation valid as from \_\_\_\_\_

Page ou ext. Page or ext.	Article Article	Description Description
1, VO	Photo A	Revised photo with production external rear view mirrors fitted Photo 95 - A
1, VO	Photo B	Revised photo with production external rear view mirrors fitted Photo 95 - B
2, VO	XX111	Revised photo with production external rear view mirrors fitted Photo 95 - XX111
4, VO	902	Angle between wing upper surface and mounting foot = 20° ± 1°. Previous angle quoted was angle to horizontal.

© FIA - FC - 1990 - 01004.FB.11.94

FEDERATION INTERNATIONALE  
DE L'AUTOMOBILE  
8, place de la Concorde, 75008 Paris  
Services Administratifs :  
8 bis, rue Boissy d'Anglas, 75008 Paris

Marque **FORD**  
Make

Modèle **MONDEO 4 DOOR**  
Model

Homologation No  
**ST-019**

**02/01 ER**

PHOTO No **95-A**



PHOTO No **95-B**



PHOTO No **95-XX111**



PHOTO No

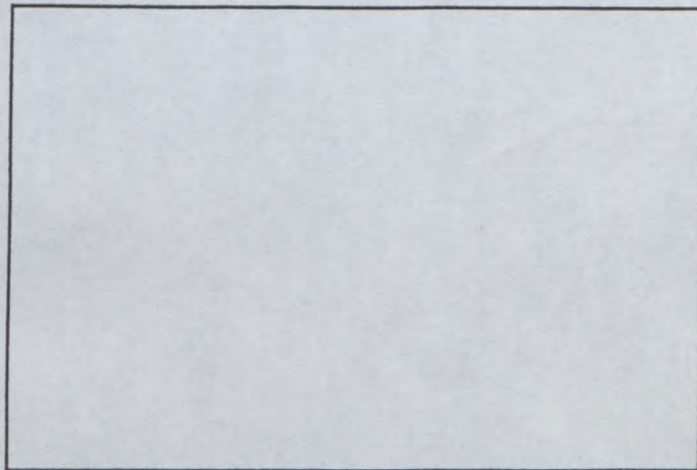

PHOTO No

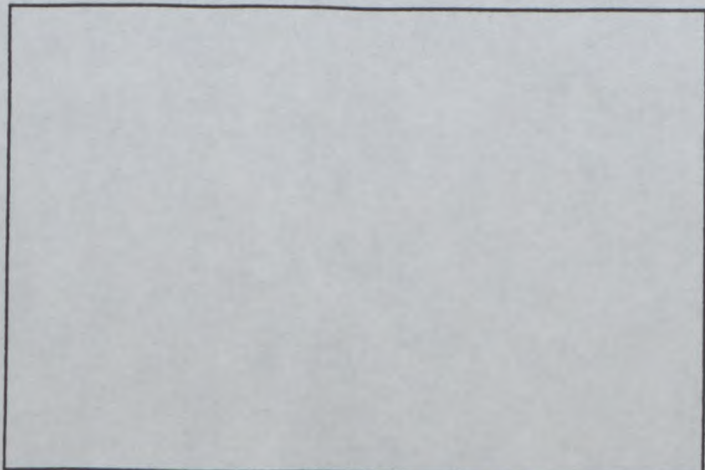
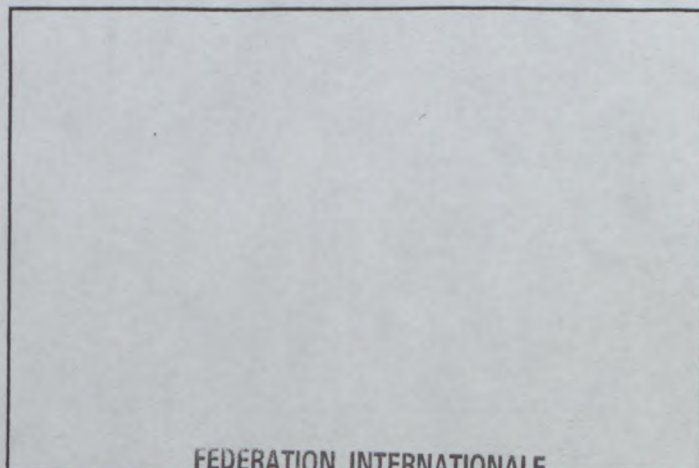

PHOTO No



**FEDERATION INTERNATIONALE  
DE L'AUTOMOBILE**

8, place de la Concorde, 75008 Paris  
Services Administratifs :  
8 bis, rue Boissy d'Anglas, 75008 Paris



# FEDERATION INTERNATIONALE DE L' AUTOMOBILE

Homologation No

ST 019

Groupe  
Group

Supertourisme  
Supertouring

03/02V0

## FICHE D'HOMOLOGATION POUR INFORMATIONS COMPLEMENTAIRES HOMOLOGATION FORM FOR COMPLEMENTARY INFORMATION

Véhicule: Constructeur  
Vehicle: Manufactureur

FORD

Modèle et type  
Model and type

MONDEO 4 Door

Homologation valable à partir du  
Homologation valid as from

01 MARS 1996

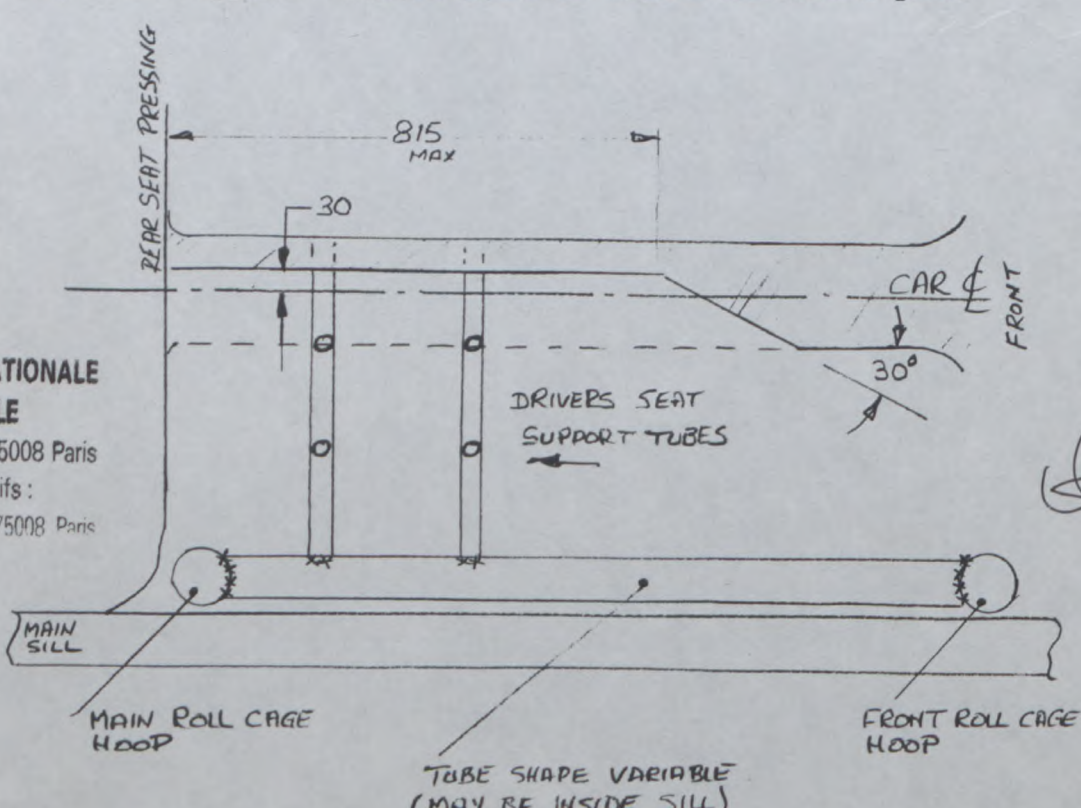
Article Article	Description Description
	<p>Maximum dimension for modification to the central tunnel for fitting the drivers seat.</p> <p>The conversion can be either on Left hand side or Right hand side, but not both.</p> <p>The free concept exhaust tunnel may be separate, or combined with the central tunnel as long as it does not exceed the regulation size.</p> <p>The seat support runners must be above the floor pan.</p> 

1981 - 03.FB.11.94  
 FEDERATION INTERNATIONALE  
 DE L'AUTOMOBILE  
 8, place de la Concorde, 75008 Paris  
 Services Administratifs :  
 8 bis, rue Boissy d'Angles, 75008 Paris



Groupe  
Group

Supertourisme  
Supertouring

04/02 ER

FICHE D'HOMOLOGATION POUR INFORMATIONS COMPLEMENTAIRES  
HOMOLOGATION FORM FOR COMPLEMENTARY INFORMATION

Véhicule: Constructeur FORD Modèle et type MONDEO 4 Door  
Vehicle: Manufactureur \_\_\_\_\_ Model and type \_\_\_\_\_

Homologation valable à partir du 1 April 1996  
Homologation valid as from \_\_\_\_\_

Article Article	Description Description
	<p>Production Front Suspension</p>

FA - FC - 1991 - 016 03 FB 1194

FEDERATION INTERNATIONALE  
DE L'AUTOMOBILE  
8, place de la Concorde, 75008 Paris  
Services Administratifs :  
8 bis, rue Boissy d'Anglas, 75008 Paris





FEDERATION INTERNATIONALE DE L' AUTOMOBILE

Homologation No

ST 019

Groupe Group

Supertourisme Supertouring

05/03 ER

FICHE D'HOMOLOGATION POUR INFORMATIONS COMPLEMENTAIRES HOMOLOGATION FORM FOR COMPLEMENTARY INFORMATION

Vehicule: Constructeur FORD Modèle et type MONDEO 4 Door
Vehicle: Manufactureur Model and type

Homologation valable à partir du 1 April 1996
Homologation valid as from

Table with 2 columns: Article / Article and Description / Description

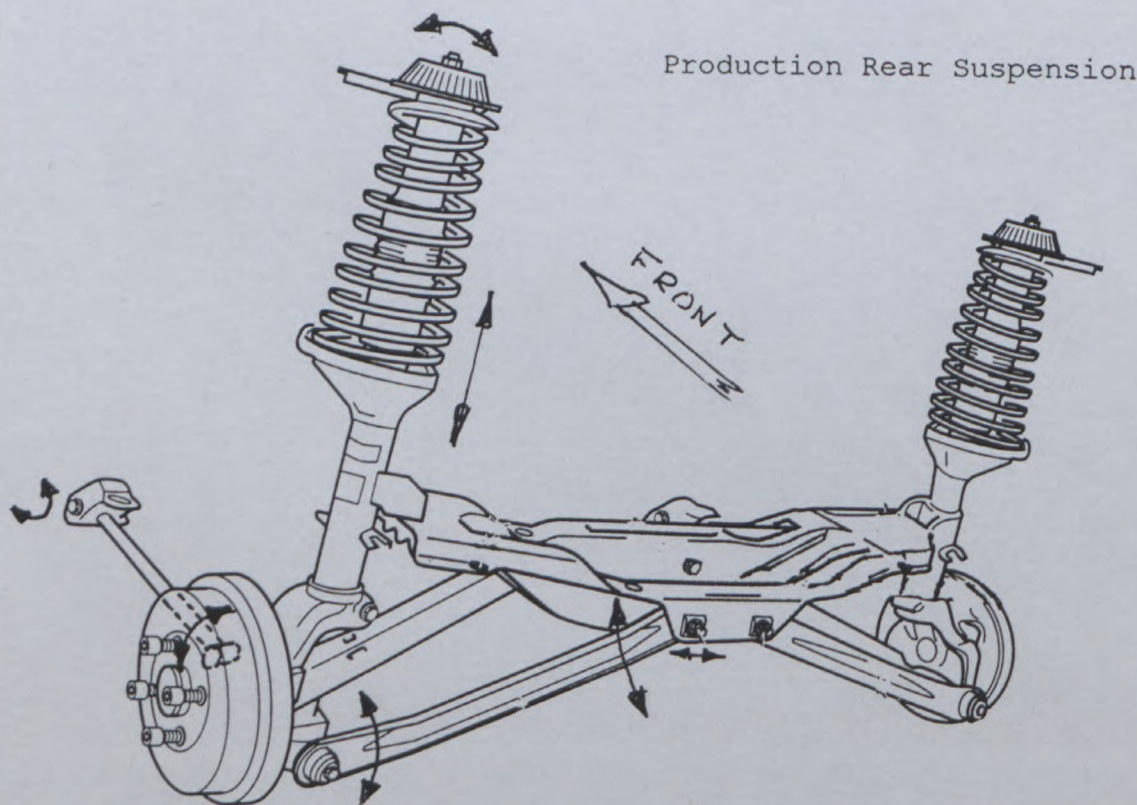

Q PA - FC - 1991 - 016 03 FB\_11\_94

Handwritten signature

FEDERATION INTERNATIONALE DE L'AUTOMOBILE
8, place de la Concorde, 75008 Paris
Services Administratifs :
8 bis, rue Boissy d'Anglas, 75008 Paris