



FEDERATION INTERNATIONALE DE L' AUTOMOBILE

Homologation No.

ST 27

Groupe Group SUPERTOURISME SUPERTOURING

FICHE D'HOMOLOGATION CONFORME A L'ANNEXE J DU CODE SPORTIF INTERNATIONAL HOMOLOGATION FORM IN ACCORDANCE WITH APPENDIX J OF THE INTERNATIONAL SPORTING CODE

Homologation valable à partir du Homologation valid as from

01 DEC. 1995

A) Voiture vue de 3/4 avant Car seen from 3/4 front



B) Voiture vue de 3/4 arrière Car seen from 3/4 rear



1. GENERALITES / GENERAL

101. Constructeur Manufacturer Adam Opel AG

102. Dénomination(s) commerciale(s) - Modèle et type Commercial name(s) - Model and type OPEL / Vauxhall Vectra B

104. Mode de construction : a) Mode : Type of car construction : Type : XXXXXX monocoque unitary construction

b) Matériau du châssis / coque Material of chassis / bodyshell Stahl / Steel

105. Nombre de volumes Number of volumes 3

106. Nombre de places Number of places 5

FISA - FC - ESM - 04B01FB1194

Handwritten signature

FEDERATION INTERNATIONALE DE L'AUTOMOBILE 8, place de la Concorde, 75008 Paris Services Administratifs : 8 bis, rue Boissy d'Anglas, 75008 Paris

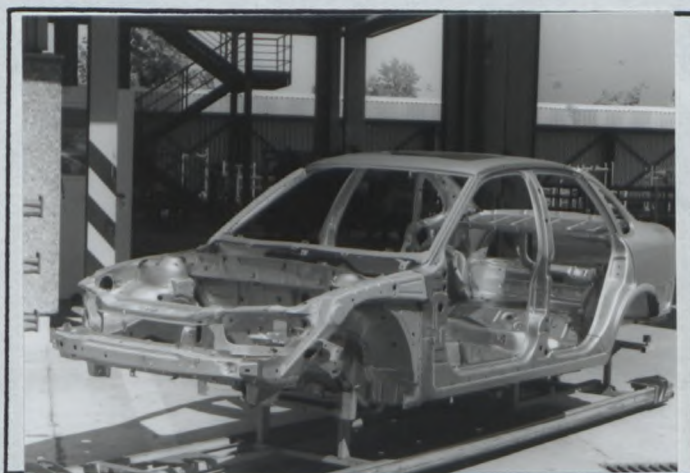

Marque  
MakeAdam Opel AGModèle  
ModelOpel / Vauxhall Vectra**ST 27**A9) Coque vue de 3/4 avant, sans portes, capots, etc.  
Bodyshell seen from 3/4 front without doors, lids, etc.A10) Coque vue de 3/4 arrière, sans portes, capots, etc.  
Bodywork seen from 3/4 rear without doors, lids, etc.**2. DIMENSIONS, POIDS / DIMENSIONS, WEIGHT**202. Longueur hors-tout 4477 mm +/- 1 %  
Overall length203. Largeur hors-tout 1707 mm +/- 1 %  
Overall widthEndroit de mesure  
Where measuredAn den vorderen Türgriffen / At the front door handles204. Largeur de carrosserie  
Width of bodyworka) A la hauteur de l'axe avant  
At front axle1699

mm +/- 1 %

b) A la hauteur de l'axe arrière  
At rear axle1697

mm +/- 1 %

206. Empattement 2640 mm +/- 1 %  
Wheelbase209. Porte-à-faux a) Avant 857 mm +/- 1 %  
Overhang Frontb) Arrière 980 mm +/- 1 %  
Rear210. Distance "G" (volant - paroi de séparation arrière) 1590 mm  
Distance "G" (steering wheel - rear bulkhead)



Marque  
Make

Adam Opel AG

Modèle  
Model

Opel / Vauxhall Vectra

ST 27

## 4. CIRCUIT DE CARBURANT / FUEL CIRCUIT

401. Réservoir : 1 b) Emplacement  
Fuel tank : Location Unterhalb der Rücksitzwanne / Underneath rear seat pan

## 6. TRANSMISSION / POWER TRAIN

601. Roues motrices : avant 

oui	non
yes	XX

 arrière 

oui	non
XX	no

  
Driven wheels : front rear

603. Boîte de vitesses : a1) Emplacement dans l'empattement  
Gearbox : Location in wheelbase 

moitié avant	moitié arrière
front half	XXXXXX

## XII) CHAÎNE CINÉMATIQUE (4 roues motrices) / KINEMATIC TRAIN (4 wheel drive):

Marque  
Make Adam Opel AGModèle  
Model Opel / Vauxhall Vectra**ST 27**

**Modifications nécessaires pour passer d'une version 2 roues motrices (au moins 2500 exemplaires) à une version 4 roues motrices (au moins 2500 exemplaires) / Modifications necessary in order to go from a 2-wheel drive version (at least 2500 cars) to a 4-wheel drive version (at least 2500 cars)**

**FEDERATION INTERNATIONALE  
DE L'AUTOMOBILE**

8, place de la Concorde, 75008 Paris

Services Administratifs :

8 bis, rue Boissy d'Anglas, 75008 Paris



Marque / Make Adam Opel AG

Modèle / Model Opel / Vauxhall Vectra

**ST 27**

**7. SUSPENSION / SUSPENSION**

701. Généralités / General

	Avant / Front	Arrière / Rear				
a) Type de suspension / Type of suspension	<b>MC PHERSON</b>	<b>MULTI LINK</b>				
702. Ressorts hélicoïdaux / Helicoïdal springs	<table border="1"> <tr><td>oui / yes</td><td>non / <b>XX</b></td></tr> </table>	oui / yes	non / <b>XX</b>	<table border="1"> <tr><td>oui / yes</td><td>non / <b>XX</b></td></tr> </table>	oui / yes	non / <b>XX</b>
oui / yes	non / <b>XX</b>					
oui / yes	non / <b>XX</b>					
703. Ressorts à lames / Leaf springs	<table border="1"> <tr><td><b>XX</b></td><td>non / no</td></tr> </table>	<b>XX</b>	non / no	<table border="1"> <tr><td><b>XX</b></td><td>non / no</td></tr> </table>	<b>XX</b>	non / no
<b>XX</b>	non / no					
<b>XX</b>	non / no					
704. Barres de torsion / Torsion bars	<table border="1"> <tr><td><b>XX</b></td><td>non / no</td></tr> </table>	<b>XX</b>	non / no	<table border="1"> <tr><td><b>XX</b></td><td>non / no</td></tr> </table>	<b>XX</b>	non / no
<b>XX</b>	non / no					
<b>XX</b>	non / no					

705. Autre type de suspension : / Other type of suspension : *Voir description sur fiche additionnelle / See description on additional form*

707. Amortisseurs : / Shock absorbers :

	Avant / Front	Arrière / Rear
a) Nombre par roue / Number per wheel	<u>1</u>	<u>1</u>

T) Train avant complet déposé / Complete dismantled front axle

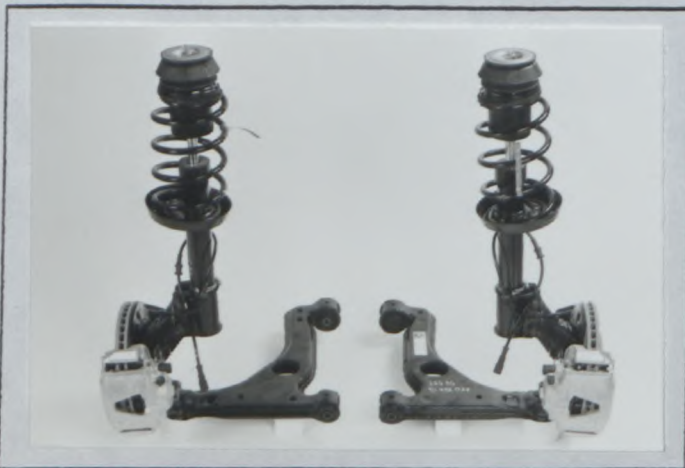

U) Train arrière complet déposé / Complete dismantled rear axle

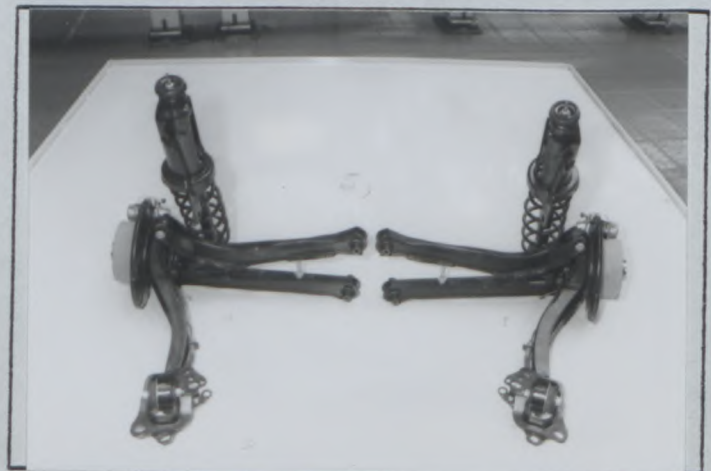

Q) FSA - FC - 834 - 04801EB1194

**8. TRAIN ROULANT / RUNNING GEAR**

804. Direction : / Steering :

	Avant / Front	Arrière / Rear
a) Type / Type	<b>Zahnstangenlenkung/</b>	<b>FEDERATION INTERNATIONALE</b>
	<b>Rack and pinion steering</b>	<b>DE L'AUTOMOBILE</b>

8. place de la Concorde, 75008 Paris  
 Services Administratifs :  
 8 bis rue Boissy d'Anglas, 75008 Paris



Marque / Make Adam Opel AG

Modèle / Model Opel / Vauxhall Vectra

Homologation No

**ST 27**

**9. CARROSSERIE / BODYWORK**

X) Tableau de bord  
Dashboard



902. Extérieur :  
Exterior :

a) Nombre de portes / Number of doors 4

b) Hayon / Tailgate

oui <b>XX</b>	non no
------------------	-----------

Avant / Front	Arrière / Rear
<u>Stahl / Steel</u>	<u>Stahl / Steel</u>

c) Matériau des portières  
Door material

d) Matériau du capot avant / Front bonnet material Stahl / Steel

e) Matériau du capot arrière / hayon / Rear bonnet / tailgate material Stahl / Steel

f) Matériau de la carrosserie / Bodywork material Stahl und Kunststoff / Steel and Plastics

h) Matériau de lunette arrière / Rear window material Sicherheitsglas / Safety glas

i) Matériau des glaces de custode / Rear quarter window material Sicherheitsglas / Safety glas

Avant / Front	Arrière / Rear
<u>Sicherheitsglas/Safety glas</u>	<u>Sicherheitsglas/Safety glas</u>
<u>Stahl-Kunstst./Steel plastics</u>	<u>Stahl-Kunstst./Steel plastics</u>

k) Matériau des vitres latérales / Side window material

l) Matériau du pare-choc / Material of bumper



Marque  
Make

Adam Opel AG

Modèle  
Model

Opel / Vauxhall Vectra

ST 27

XII) PARTIES DE CARROSSERIE SYNTHETIQUES / SYNTHETIC PARTS OF THE BODY :

- 1- Vorderer und hinterer Stoßstangen Spoiler / Front and rear bumper spoiler
- 2- Kühlergrill / Front grille
- 3- Seitliche Schutzleiste / Side protection
- 4- Spiegelgehäuse / Mirror housings

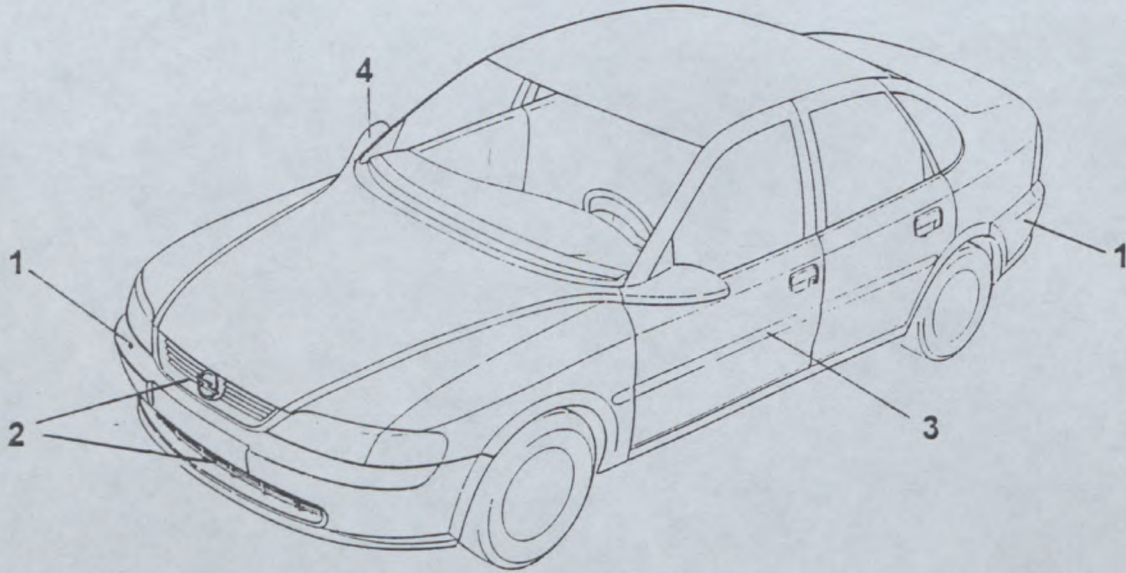

INFORMATIONS COMPLEMENTAIRES / COMPLEMENTARY INFORMATION :



Front grill Vauxhall

FEDERATION INTERNATIONALE  
DE L'AUTOMOBILE

8, place de la Concorde, 75008 Paris

Services Administratifs.

8 bis, rue Boissy d'Anglas, 75008 Paris





FEDERATION INTERNATIONALE DE L'AUTOMOBILE

Homologation No

**ST 27**

Groupes  
Group

**A/B/N/T1 / Supertourisme  
Supertouring**

Extension No

**CERTIFICAT DE DIMENSIONS INTERIEURES  
CERTIFICATE FOR INTERIOR DIMENSIONS**

Véhicule: Constructeur  
Vehicle: Manufactureur

**Adam Opel AG**

Modèle et type  
Model and type

**Opel / Vauxhall  
Vectra**

Dimensions intérieures comme définies par le Règlement d'Homologation  
Interior dimensions as defined by the Homologation Regulations

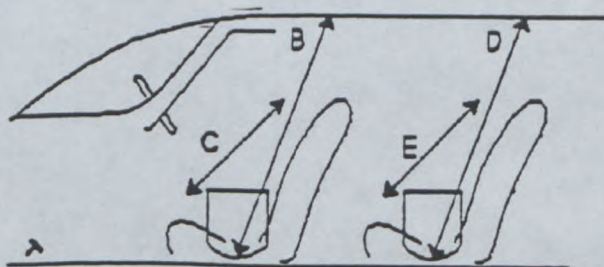

<b>B</b>	(Hauteur sur sièges avant) (Height above front seats)	<b>1010</b>	mm
<b>C</b>	(Largeur aux sièges avant) (Width at front seats)	<b>1384</b>	mm
<b>D</b>	(Hauteur sur sièges arrière) (Height above rear seats)	<b>950</b>	mm
<b>E</b>	(Largeur aux sièges arrière) (Width at rear seats)	<b>1390</b>	mm

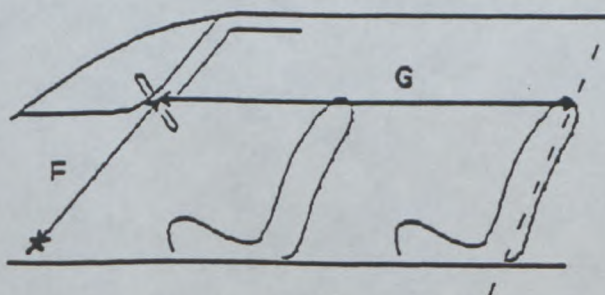

<b>F</b>	(Volant - Pédale de frein) (Steering wheel - Brake pedal)	<b>680</b>	mm
<b>G</b>	(Volant - paroi de séparation arrière) (Steering wheel - rear bulkhead)	<b>1590</b>	mm
<b>H</b>	<b>= F + G =</b>	<b>2270</b>	mm

**FEDERATION INTERNATIONALE  
DE L'AUTOMOBILE**

8, place de la Concorde, 75008 Paris

Services Administratifs :

9 bis rue de la Harpe, 75008 Paris





FEDERATION INTERNATIONALE  
DE L'AUTOMOBILE

Homologation n°

ST 27

Extension N°

01/01V0

VO

FICHE D'EXTENSION D'HOMOLOGATION POUR DISPOSITIFS AERODYNAMIQUES EN SUPERTOURISME  
HOMOLOGATION EXTENSION FORM FOR AERODYNAMIC DEVICES IN SUPER TOURING

Homologation valable à partir du  
Homologation valid as from

01 DEC. 1995

Adam Opel AG

Opel / Vauxhall Vectra-B

A) Voiture vue de 3/4 avant  
Car seen from 3/4 front

B) Voiture vue de 3/4 arrière  
Car seen from 3/4 rear



9. CARROSSERIE / BODYWORK

XVI) DISPOSITIF AVANT DEPOSE ET VU DE FACE AVEC DIMENSIONS DES OUVERTURES :  
DISMOUNTED FRONT DEVICE SEEN FROM FRONT WITH DIMENSIONS OF OPENINGS:

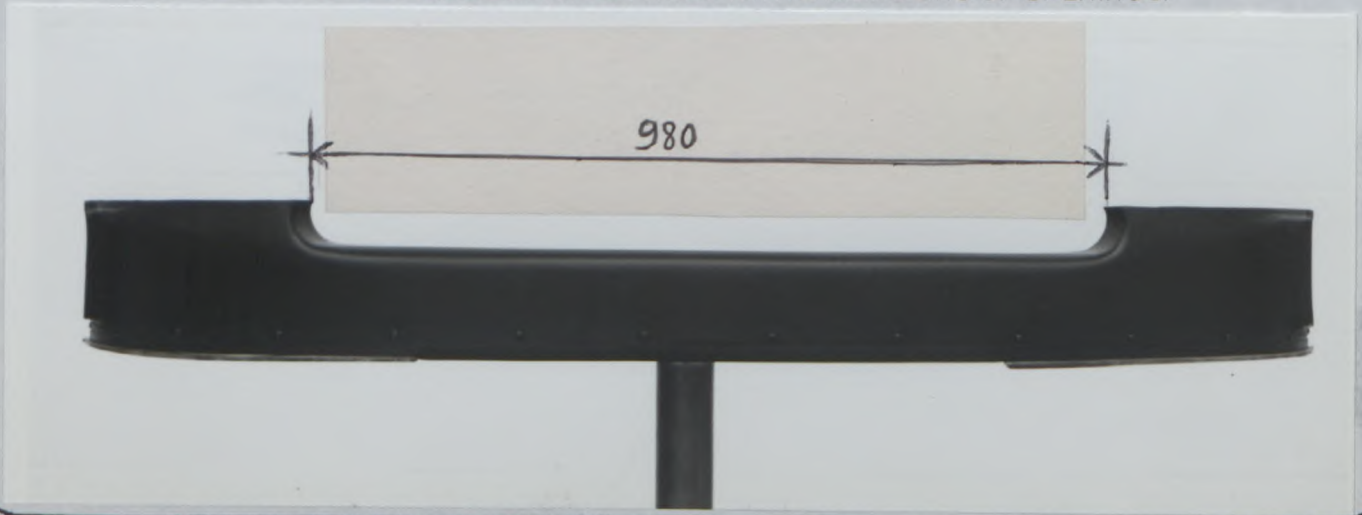

FEDERATION INTERNATIONALE  
DE L'AUTOMOBILE

8, place de la Concorde, 75008 Paris

Services Administratifs :

8 bis, rue Boissy d'Anglas, 75008 Paris

All dimensions : +/- 1%



Marque  
Make

Adam Opel AG

Modèle  
Model

Opel / Vauxhall  
Vectra-B

Homologation N°

ST 27

Extension N°

01/01V0

XVIII) DISPOSITIF AVANT DEPOSE ET VU DE COTE AVEC DIMENSIONS DES OUVERTURES :  
DISMOUNTED FRONT DEVICE IN SIDE VIEW WITH DIMENSIONS OF OPENINGS:

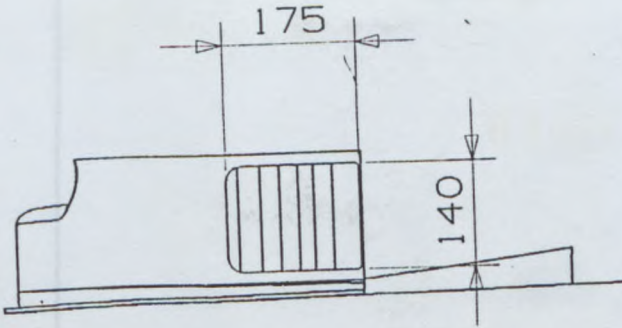

XXIII) DISPOSITIF AVANT EN PLACE ET VU DE FACE :  
MOUNTED FRONT DEVICE SEEN FROM FRONT:



XXIV) DISPOSITIF AVANT EN PLACE ET VU DE COTE :  
MOUNTED FRONT DEVICE IN SIDE VIEW:



FEDERATION INTERNATIONALE  
DE L'AUTOMOBILE

8, place de la Concorde, 75008 Paris

Services Administratifs :

8 bis, rue Boissy d'Anglas, 75008 Paris



Marque  
Make

Adam Opel AG

Modèle  
Model

Opel / Vauxhall Vectra-B

Homologation N°

ST 27

Extension N°

01/01V0

XVII) DISPOSITIF ARRIERE EN PLACE  
ET VU DE COTE :  
MOUNTED REAR DEVICE IN SIDE VIEW:



XIX) SECTION DU DISPOSITIF ARRIERE AU  
NIVEAU DE L'AXE LONGITUDINAL DE LA  
VOITURE :  
SECTION OF REAR DEVICE AT CAR'S  
CENTERLINE LEVEL:

See Page 4

XX) DISPOSITIF ARRIERE EN PLACE ET VU DE DESSUS :  
MOUNTED REAR DEVICE SEEN FROM ABOVE:



XXI) DISPOSITIF ARRIERE DEPOSE ET  
VU DE COTE :  
DISMOUNTED REAR DEVICE IN SIDE VIEW:



FEDERATION INTERNATIONALE  
DE L'AUTOMOBILE

8, place de la Concorde, 75008 Paris

Services Administratifs :

8 bis, rue Boissy d'Anglas, 75008 Paris



Marque  
Make

Adam Opel AG

Modèle  
Model

Opel / Vauxhall Vectra-B

Homologation N°

ST 27

Extension N°

01/01V0

XXII) DISPOSITIF ARRIERE DEPOSE ET VU DE DESSUS :  
DISMOUNTED REAR DEVICE SEEN FROM ABOVE:



902. Extérieur :  
Exterior:

p) Angle entre dispositif arrière et carrosserie  
Angle between rear device and bodywork

14° +/- 1°



INFORMATIONS COMPLÉMENTAIRES / COMPLEMENTARY INFORMATION :

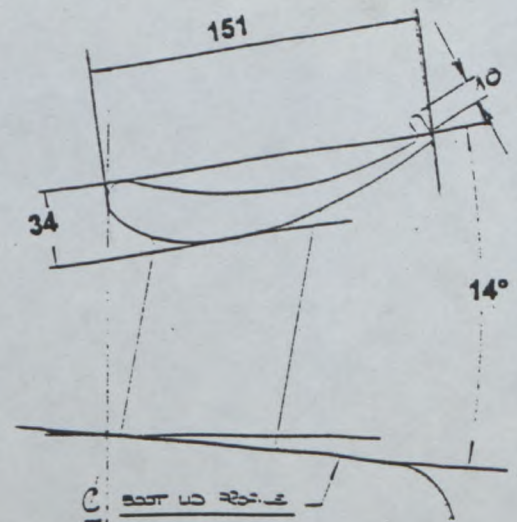
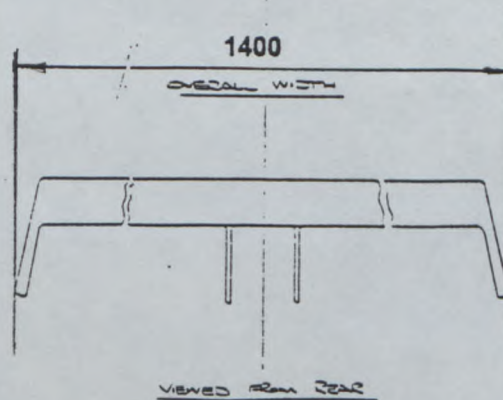

FEDERATION INTERNATIONALE  
DE L'AUTOMOBILE

8, place de la Concorde, 75008 Paris

Services Administratifs :

8 bis, rue Boissy d'Anglas, 75008 Paris





FEDERATION INTERNATIONALE DE L'AUTOMOBILE

Homologation N°

ST 27

VO

Extension N°

02 / 02 VO

Adam Opel AG

Opel / Vauxhall Vectra-B

FICHE D'EXTENSION D'HOMOLOGATION POUR DISPOSITIFS AERODYNAMIQUES EN SUPERTOURISME  
HOMOLOGATION EXTENSION FORM FOR AERODYNAMIC DEVICES IN SUPER TOURING

Homologation valable à partir du  
Homologation valid as from

01 MARS 1996

A) Voiture vue de 3/4 avant  
Car seen from 3/4 front



B) Voiture vue de 3/4 arrière  
Car seen from 3/4 rear



9. CARROSSERIE / BODYWORK

XVI) DISPOSITIF AVANT DEPOSE ET VU DE FACE AVEC DIMENSIONS DES OUVERTURES :  
DISMOUNTED FRONT DEVICE SEEN FROM FRONT WITH DIMENSIONS OF OPENINGS:

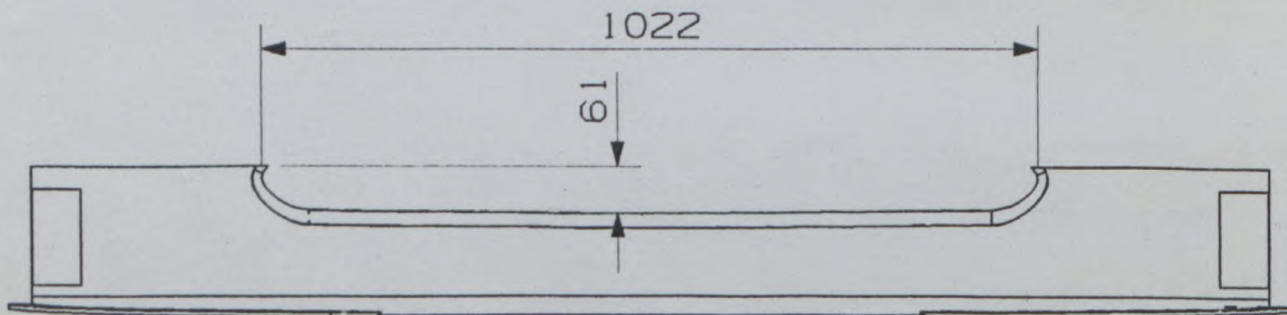

FEDERATION INTERNATIONALE DE L'AUTOMOBILE

8, place de la Concorde, 75008 Paris

Services Administratifs :

8 bis, rue Boissy d'Anglas, 75008 Paris

All dimensions : +/- 1 %



Marque  
Make

Adam Opel AG

Modèle  
Model

Opel / Vauxhall  
Vectra-B

Homologation: N°

ST 27

Extension: N°

02/02V0

XVIII) DISPOSITIF AVANT DEPOSE ET VU DE COTE AVEC DIMENSIONS DES OUVERTURES :  
DISMOUNTED FRONT DEVICE IN SIDE VIEW WITH DIMENSIONS OF OPENINGS:



FEDERATION INTERNATIONALE  
DE L'AUTOMOBILE

8, place de la Concorde, 75008 Paris

Services Administratifs :

8 bis, rue Boissy d'Anglas, 75008 Paris

XXIII) DISPOSITIF AVANT EN PLACE ET VU DE FACE :  
MOUNTED FRONT DEVICE SEEN FROM FRONT:



XXIV) DISPOSITIF AVANT EN PLACE ET VU DE COTE :  
MOUNTED FRONT DEVICE IN SIDE VIEW:





Marque  
Make Adam Opel AG

Modèle  
Model Opel / Vauxhall Vectra-B

Homologation N°

**ST 27**

Extension N°

**02/02 V0**

XVII) DISPOSITIF ARRIERE EN PLACE  
ET VU DE COTE :  
MOUNTED REAR DEVICE IN SIDE VIEW:



XIX) SECTION DU DISPOSITIF ARRIERE AU  
NIVEAU DE L'AXE LONGITUDINAL DE LA  
VOITURE :  
SECTION OF REAR DEVICE AT CAR'S  
CENTERLINE LEVEL:

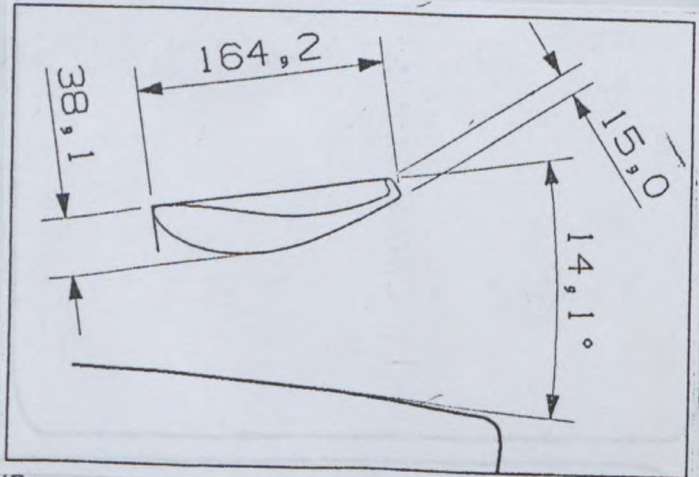

XX) DISPOSITIF ARRIERE EN PLACE ET VU DE DESSUS :  
MOUNTED REAR DEVICE SEEN FROM ABOVE:

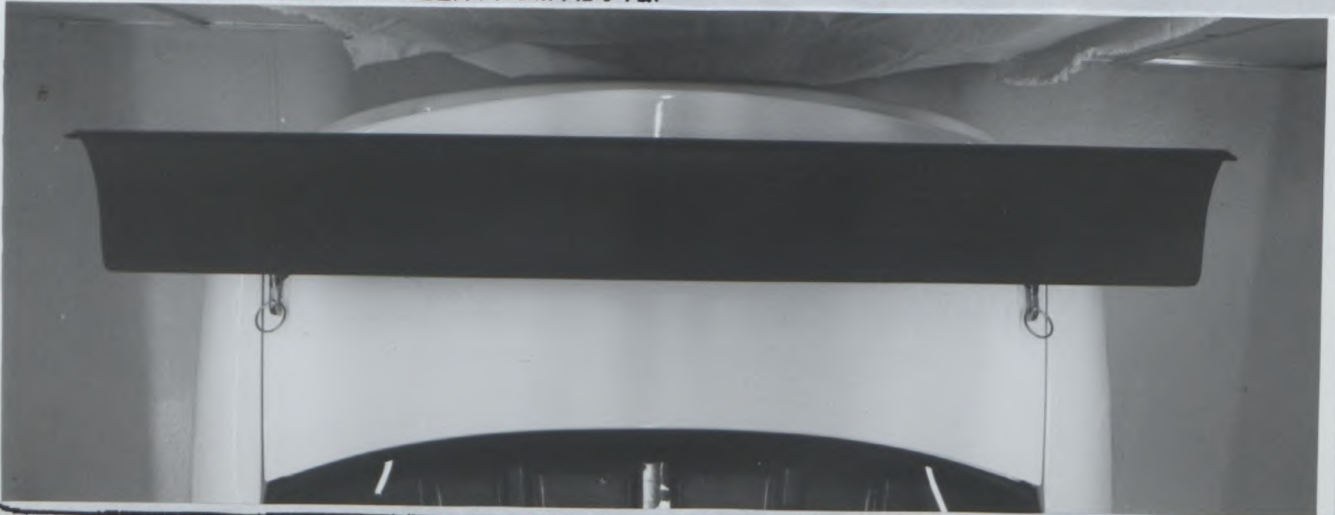

XXI) DISPOSITIF ARRIERE DEPOSE ET  
VU DE COTE :  
DISMOUNTED REAR DEVICE IN SIDE VIEW:



**All dimensions : +/- 1 %**

**FEDERATION INTERNATIONALE  
DE L'AUTOMOBILE**

8, place de la Concorde, 75008 Paris

Services Administratifs :

8 bis, rue Boissy d'Anglas, 75008 Paris



Marque  
Make

Adam Opel AG

Modèle  
Model

Opel / Vauxhall Vectra-B

Homologation N°

ST 27

Extension N°

02/02V0

XXII) DISPOSITIF ARRIERE DEPOSE ET VU DE DESSUS :  
DISMOUNTED REAR DEVICE SEEN FROM ABOVE:

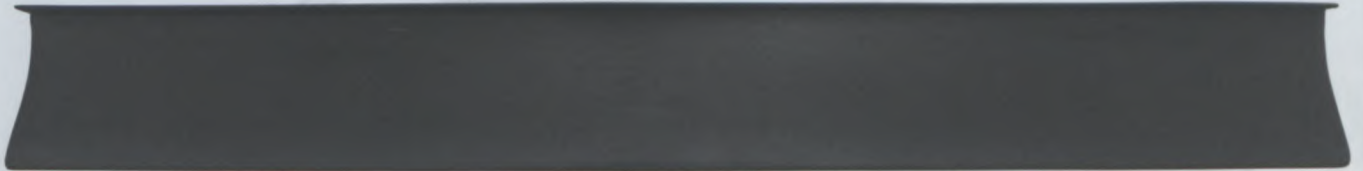

902. Extérieur :  
Exterior:

p) Angle entre dispositif arrière et carrosserie  
Angle between rear device and bodywork

14 +/- 1°



INFORMATIONS COMPLÉMENTAIRES / COMPLEMENTARY INFORMATION :

The recess in the front aerodynamic device is shaped to suit the standard road car radiator intake grill which is fitted to the race car.

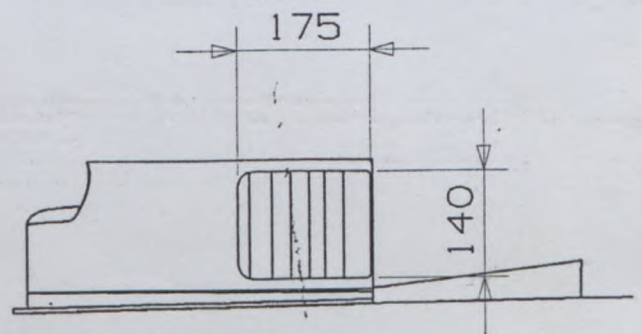
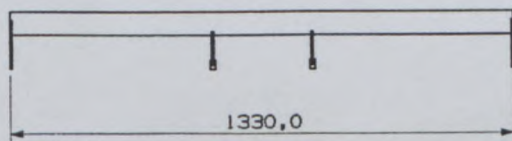

FEDERATION INTERNATIONALE  
DE L'AUTOMOBILE

8, place de la Concorde, 75008 Paris

Services Administratifs :

8 bis, rue Boissy d'Anglas, 75008 Paris

All dimensions : +/- 1 %





FEDERATION INTERNATIONALE  
DU SPORT AUTOMOBILE

ONS

Oberste Nationale Sportkommission  
für den Automobilsport in Deutschland GmbH

Homologation Nr.  
Homologation No.

ST - 27

Nachtrag Nr.  
Extension No.

03 / 01 ER

Gruppe ~~AXX~~ ~~BXX~~ ~~NXX~~ ~~TX~~  
Group ~~A~~ ~~B~~ ~~N~~ ~~T~~  
**SUPERTOURING**

Nachtrag zum Homologationsblatt  
Form of homologation extension

ES Sportevolution des Typs  
Sporting evolution of the type

VO Ausstattungsvariante  
Option variant

ET Normale Evolution des Typs  
Normal evolution of the type

ER Berichtigung  
Erratum

VF Liefervariante  
Supply variant

Fahrzeughersteller: Adam Opel AG  
Vehicle Manufacturer

Modell und Typ: Opel / Vauxhall Vectra  
Model and Type

Homologation gültig ab: 01 JUN 1996  
Homologation valid as from

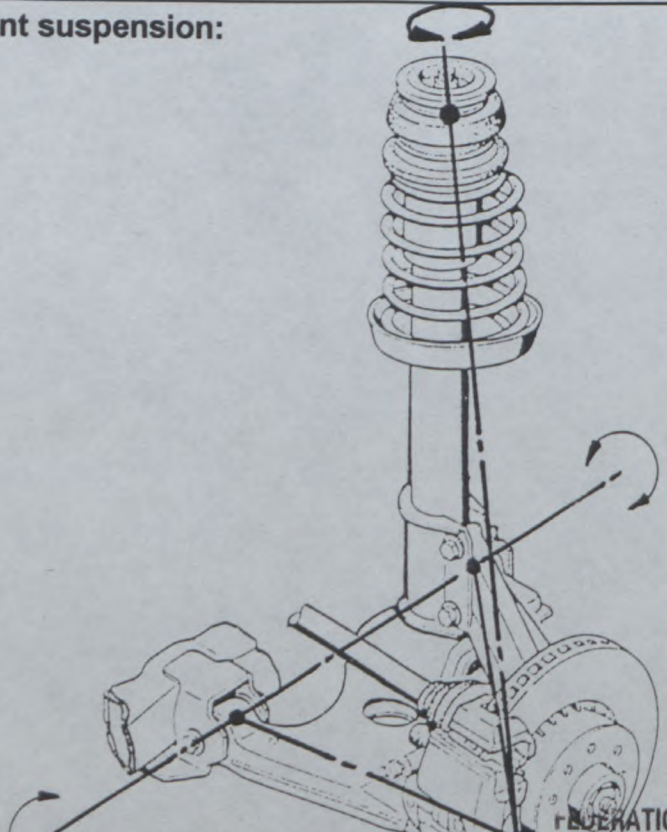
Seite oder Nachtrag Page or extension	Artikel Article	Beschreibung Description
5	7	<p><b>Front suspension:</b></p> 

*Handwritten signature*

FEDERATION INTERNATIONALE  
DE L'AUTOMOBILE  
8, place de la Concorde, 75008 Paris  
Services Administratifs :  
8 bis, rue Boissy d'Anglas, 75008 Paris



Marke  
Make

**Adam Opel AG**

Modell  
Model

**Opel / Vauxhall  
Vectra**

Homologation Nr.  
Homologation No.

**ST - 27**

Nachtrag Nr.  
Extension No.

**03 / 01 ER**

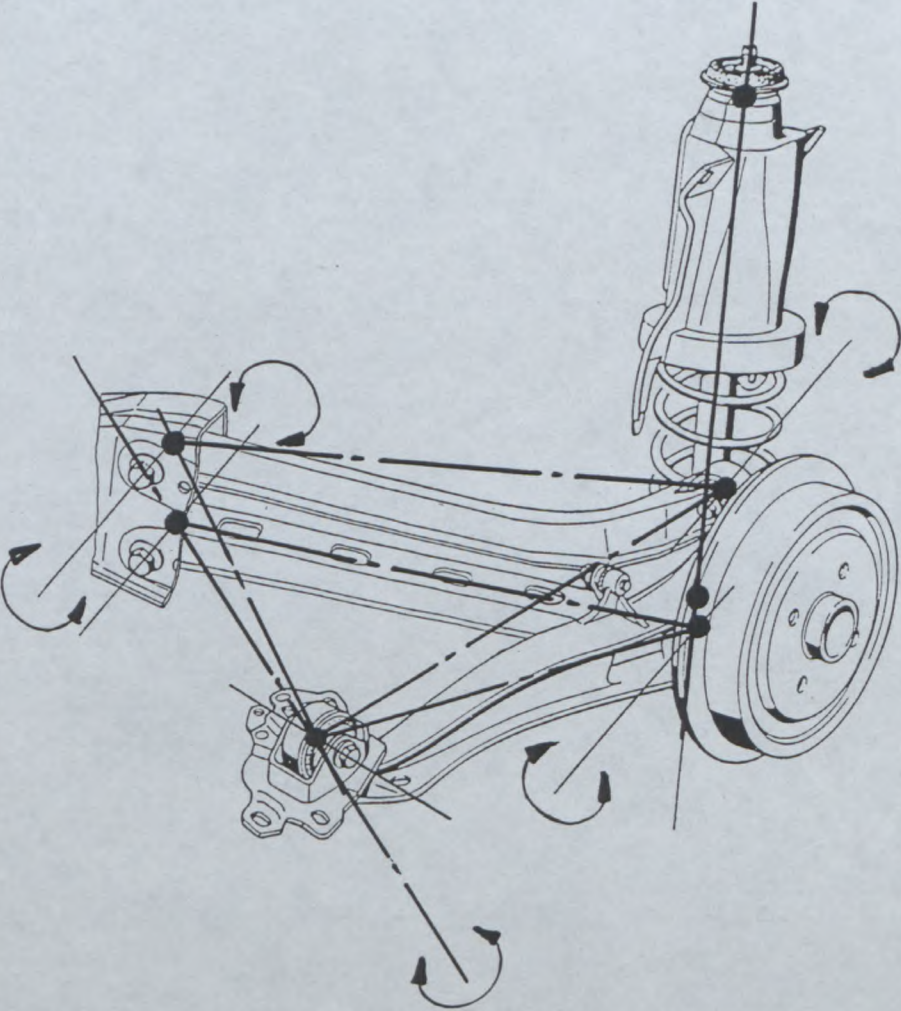
Seite oder Nachtrag Page or extension	Artikel Article	Beschreibung Description
5	7	<b>Rear suspension:</b>  

**FEDERATION INTERNATIONALE  
DE L'AUTOMOBILE**

8, place de la Concorde, 75008 Paris

Services Administratifs :

8 bis, rue Boissy d'Anglas, 75008 Paris





FEDERATION INTERNATIONALE  
DE L'AUTOMOBILE

Homologation No

ST 27

Groupe A/B/N/T1 / Supertourisme  
Group Supertouring

Extension No

04 / 02 ER

FICHE D'EXTENSION D'HOMOLOGATION  
FORM OF HOMOLOGATION EXTENSION

- ES Evolution sportive du type / Sporting evolution of the  VO Variante option / Option variant
- ET Evolution normale du type / Normal evolution of the  ER Erratum / Erratum
- VF Variante de fourniture / Supply variant

Véhicule: Constructeur ADAM OPEL AG Modèle et type Opel/Vauxhall Vectra  
Vehicle: Manufactureur Model and type

Homologation valable à partir du 01 OCT. 1996  
Homologation valid as from

Page ou ext. Page or ext.	Article Article	Description Description
		Ref. Drawing 13 - Synthetic parts of the body : Add "polycarbonate"

FEDERATION INTERNATIONALE  
DE L'AUTOMOBILE  
8, place de la Concorde, 75008 Paris  
Services Administratifs :  
8 bis, rue Boissy d'Anglas, 75008 Paris

(\*) FIA - FC - 1990 - 01004.FB.1194





FEDERATION INTERNATIONALE  
DE L'AUTOMOBILE

Homologation No

**ST - 027**

Groupe  
Group

~~XXXXXXX~~ / Supertourisme  
Supertouring

Extension No

**05 / 03 VO**

FICHE D'EXTENSION D'HOMOLOGATION POUR ARMATURE DE SECURITE  
FORM OF HOMOLOGATION EXTENSION FOR SAFETY CAGE

VO Variante option / Option variant

Véhicule: Constructeur  
Vehicle: Manufactureur

Adam Opel AG

Modèle et type  
Model and type

OPEL / Vauxhall Vectra

Homologation valable à partir du  
Homologation valid as from

**01 MARS 1997**

	Arceau principal Main rollbar	Entretoise longitudinale Longitudinal strut	Entretoise diagonale Diagonal Strut	Arceau avant Front rollbar
Matériau Material	<u>Steel</u>	<u>Steel</u>	<u>Steel</u>	<u>Steel</u>
Diamètre extérieur Exterior diameter	<u>44,1</u> mm	<u>44,1</u> mm	<u>38,1</u> mm	<u>38,1</u> mm
Épaisseur de paroi Wall thickness	<u>1,2</u> mm	<u>1,2</u> mm	<u>0,91</u> mm	<u>0,91</u> mm
Limite élastique Elastic limit	<u>650</u> N/mm <sup>2</sup>	<u>650</u> N/mm <sup>2</sup>	<u>650</u> N/mm <sup>2</sup>	<u>650</u> N/mm <sup>2</sup>
Résistance à la traction Tensile strength	<u>720-780</u> N/mm <sup>2</sup>	<u>720-780</u> N/mm <sup>2</sup>	<u>720-780</u> N/mm <sup>2</sup>	<u>720-780</u> N/mm <sup>2</sup>

All tubes are welded

Fabricant de l'armature  
Structure manufacturer

SUPERPOWER ENGINEERING

Poids total y compris les fixations  
Total weight including fixations

45,0 kg

Armature complète hors de la voiture  
Complete structure outside the car

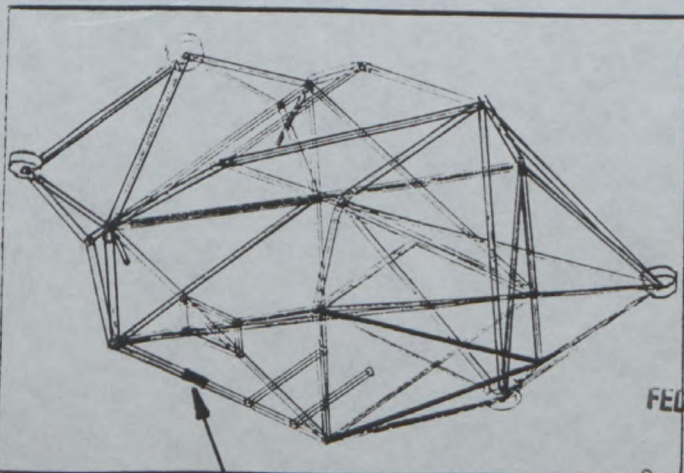

**SE-97 ST-027**

Nous attestons que la présente armature de sécurité répond aux dispositions de l'Annexe J de la FIA, en particulier en ce qui concerne ses implantations, ses connexions, et ses résistances aux contraintes.

We certify that the present safety structure complies with the conditions of the FIA Appendix J, in particular with regard to its attachments, its connections, and its stress resistances.

Signature du représentant du constructeur du véhicule  
Signature of the car manufacturer representative

FEDERATION INTERNATIONALE  
DE L'AUTOMOBILE

8, place de la Concorde, 75008 Paris  
Services Administratifs:  
8 bis, rue Boissy d'Anglas, 75008 Paris

*[Signature]*  
W.P. Flohr



Marque / OPEL/VAUXHALL  
Make

Modèle / VECTRA  
Model

Homologation No

ST 27

Extension No

05/03VO

PHOTO No 1

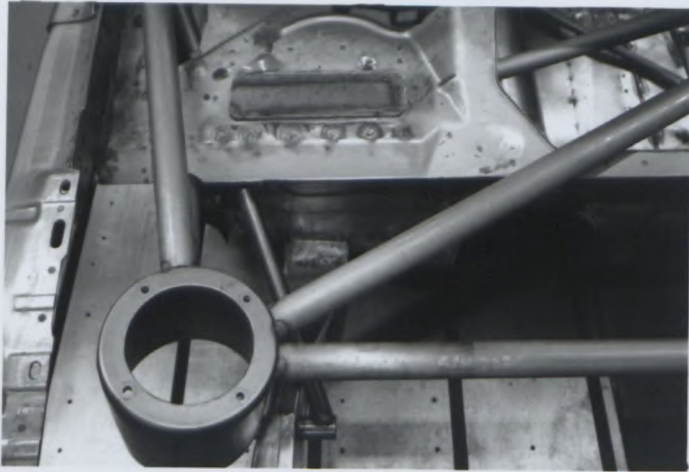

PHOTO No 2



PHOTO No 5



PHOTO No 6

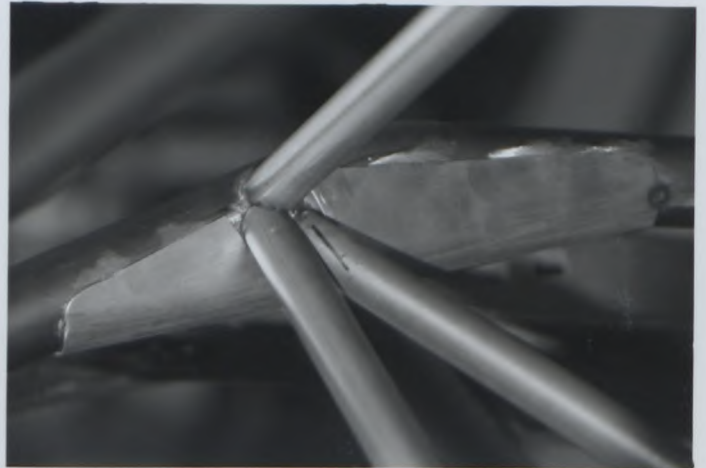

PHOTO No 3



PHOTO No 4





Marque, OPEL/VAUXHALL  
Make

Modèle VECTRA  
Model

Homologation No

**ST 27**

Extension No

**05/03VO**

PHOTO No 7

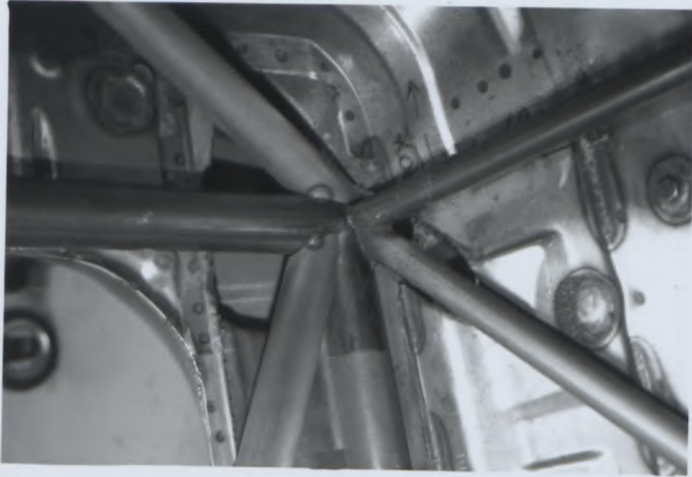

PHOTO No 8

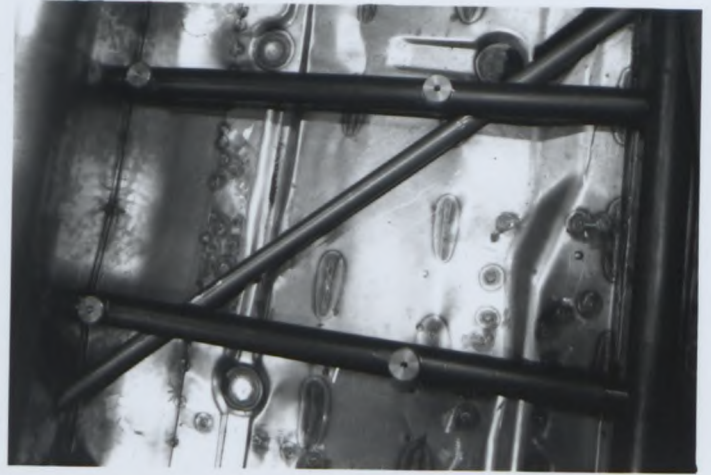

PHOTO No 9

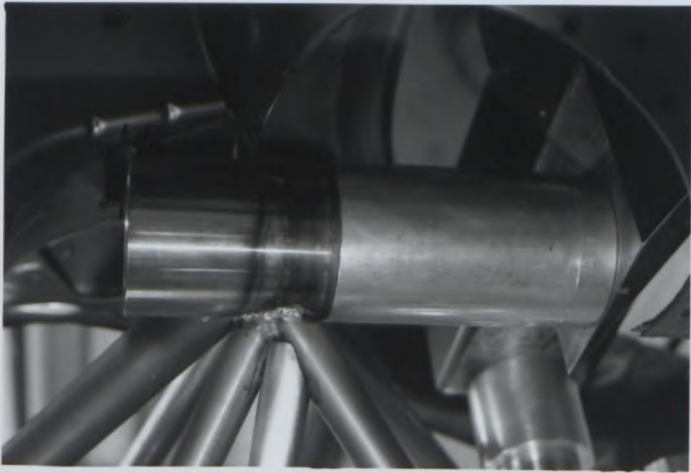

PHOTO No 10

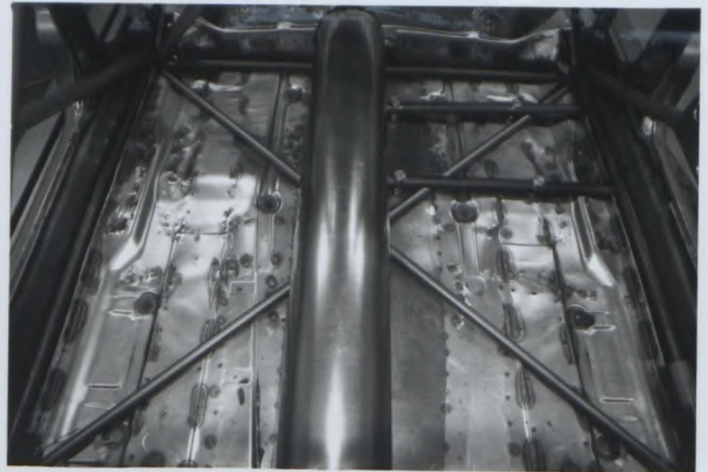

PHOTO No 11

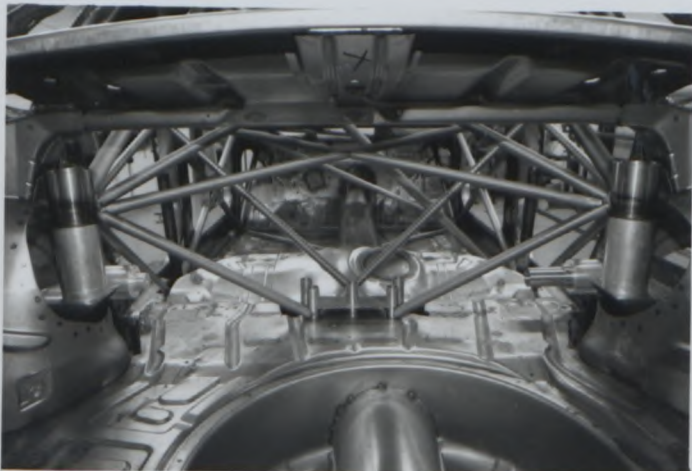
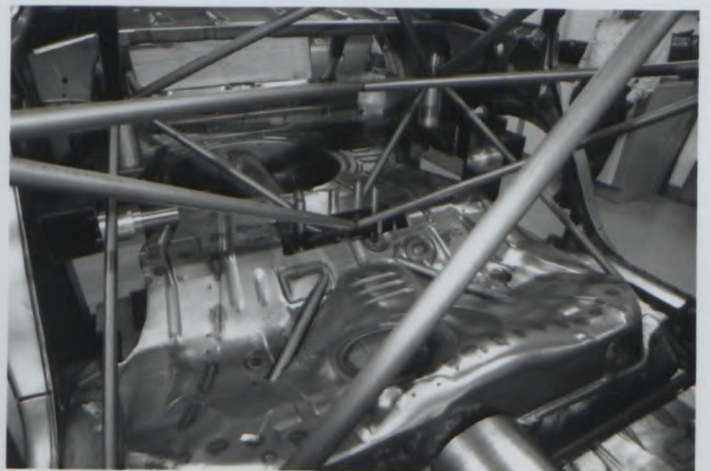

PHOTO No 12



FEDERATION INTERNATIONALE  
DE L'AUTOMOBILE

8, place de la Concorde, 75008 Paris

Services Administratifs :

8 bis, rue Boissv d'Anolas, 75008 Paris



Marque \_\_\_\_\_  
Make \_\_\_\_\_

Modèle \_\_\_\_\_  
Model \_\_\_\_\_

Homologation N°

**ST 27**

Extension N°

**05/03V0**

PHOTO N°

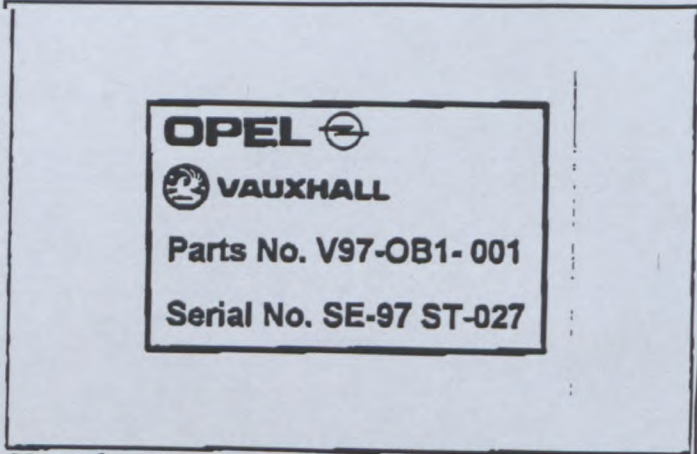

**Manufacturer Identificat. Label SE-97 ST-027**

PHOTO N°

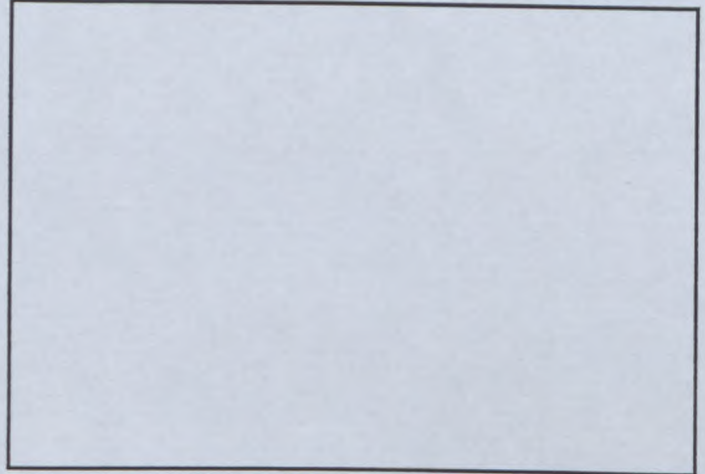

PHOTO N°

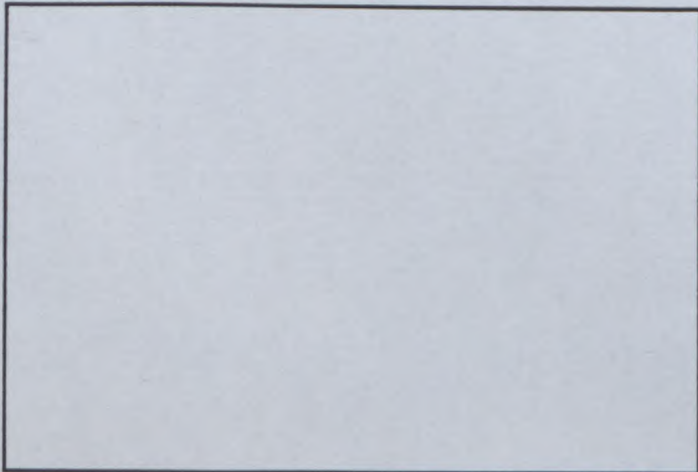

PHOTO N°

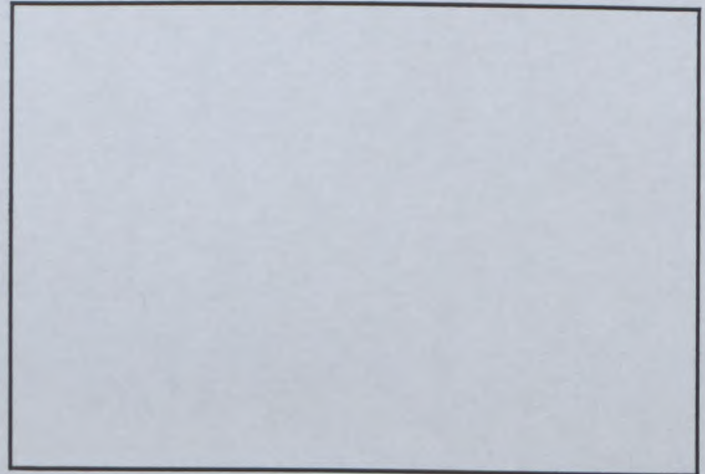

PHOTO N°

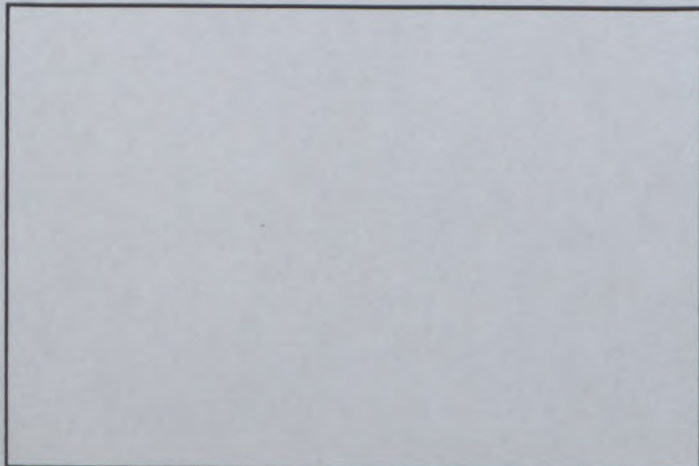

PHOTO N°



**FEDERATION INTERNATIONALE  
DE L'AUTOMOBILE**

8, place de la Concorde, 75008 Paris

Services Administratifs :

8 bis, rue Boissy d'Anglas, 75008 Paris





FEDERATION INTERNATIONALE  
DE L'AUTOMOBILE

Homologation No

**ST - 027**

Groupe  
Group

**XXXXXXXXXX**

Supertourisme  
Supertouring

Extension No

**06 / 04 VO**

FICHE D'EXTENSION D'HOMOLOGATION POUR ARMATURE DE SECURITE  
FORM OF HOMOLOGATION EXTENSION FOR SAFETY CAGE

VO Variante option / Option variant

Véhicule: Constructeur  
Vehicle: Manufactureur

**Adam Opel AG**

Modèle et type  
Model and type

**OPEL / Vauxhall Vectra**

Homologation valable à partir du  
Homologation valid as from

**01 MARS 1997**

	Arceau principal Main rollbar	Entretoise longitudinale Longitudinal strut	Entretoise diagonale Diagonal Strut	Arceau avant Front rollbar
Matériau Material	<b>Steel</b>	<b>Steel</b>	<b>Steel</b>	<b>Steel</b>
Diamètre extérieur Exterior diameter	<b>38,1</b> mm	<b>25,4</b> mm	<b>38,1</b> mm	<b>38,1</b> mm
Épaisseur de paroi Wall thickness	<b>1,6</b> mm	<b>0,9</b> mm	<b>0,9/1,6</b> mm	<b>1,6</b> mm
Limite élastique Elastic limit	<b>660-770</b> N/mm <sup>2</sup>	<b>660-770</b> N/mm <sup>2</sup>	<b>660-770</b> N/mm <sup>2</sup>	<b>660-770</b> N/mm <sup>2</sup>
Résistance à la traction Tensile strength	<b>740-840</b> N/mm <sup>2</sup>	<b>740-840</b> N/mm <sup>2</sup>	<b>740-840</b> N/mm <sup>2</sup>	<b>740-840</b> N/mm <sup>2</sup>

All tubes are welded

Fabricant de l'armature  
Structure manufacturer

**SMS AG**

Poids total y compris les fixations  
Total weight including fixations

**45,5**

kg

Armature complète hors de la voiture  
Complete structure outside the car

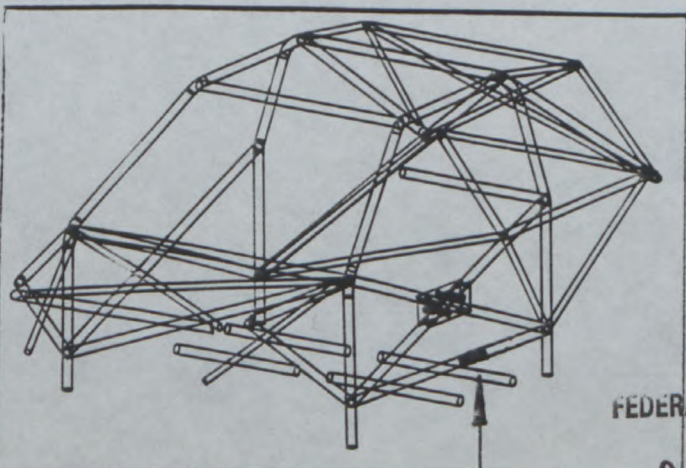

**SMS ST-027**

Vous attestons que la présente armature de sécurité répond aux dispositions de l'Annexe J de la FIA, en particulier en ce qui concerne ses implantations, ses connexions, et ses résistances aux contraintes.

We certify that the present safety structure complies with the conditions of the FIA Appendix J, in particular with regard to its attachments, its connections, and its stress resistances.

Signature du représentant du constructeur du véhicule  
Signature of the car manufacturer representative

FEDERATION INTERNATIONALE  
DE L'AUTOMOBILE

8, place de la Concorde, 75008 Paris  
Services Administratifs :  
8 bis, rue Boissy d'Anglas, 75008 Paris

**W.P. Flohr**



Marque  
Make Opel

Modèle  
Model Vauxhall Vectra

Homologation No  
**ST 27**

Extension No  
**06/04VO**

PHOTO No 1

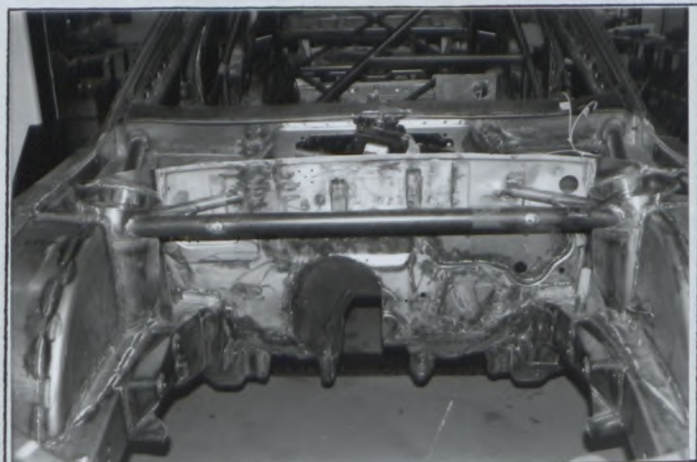

PHOTO No 2

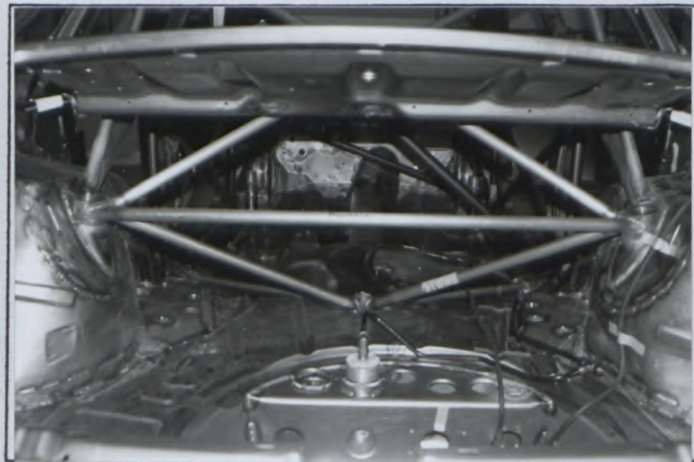

PHOTO No 3



PHOTO No 4



PHOTO No 5

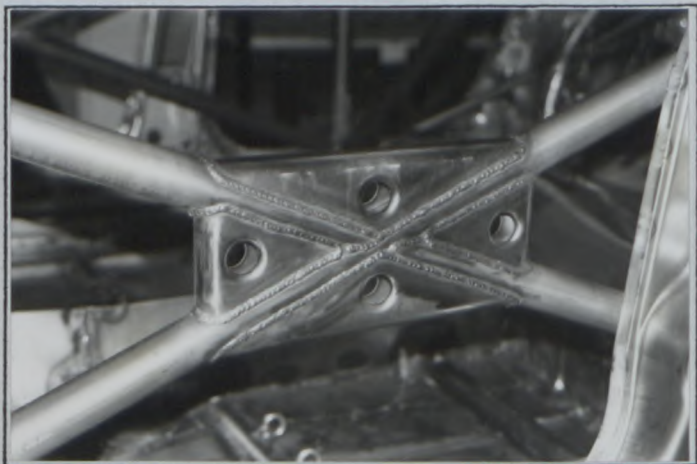

PHOTO No 6



**FEDERATION INTERNATIONALE  
DE L'AUTOMOBILE**

8, place de la Concorde, 75008 Paris

Services Administratifs :

8 bis, rue Boissy d'Anglas, 75008 Paris



Marque Opel  
Make

Modèle Vauxhall Vectra  
Model

Homologation No  
**ST 27**

Extension No  
**06/04VO**

PHOTO No 7



PHOTO No 8

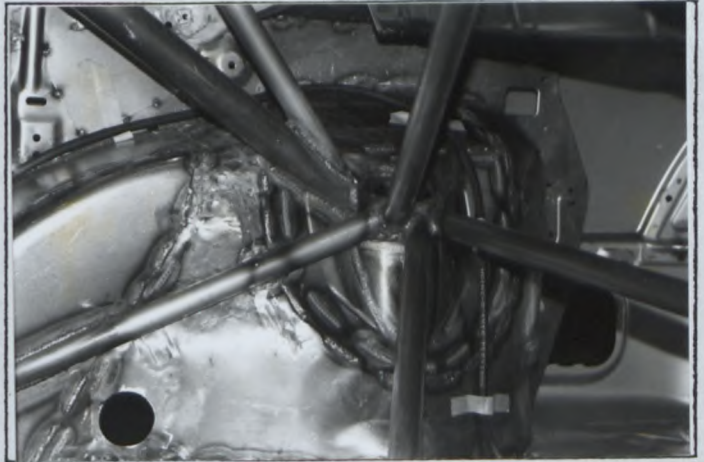

PHOTO No 9

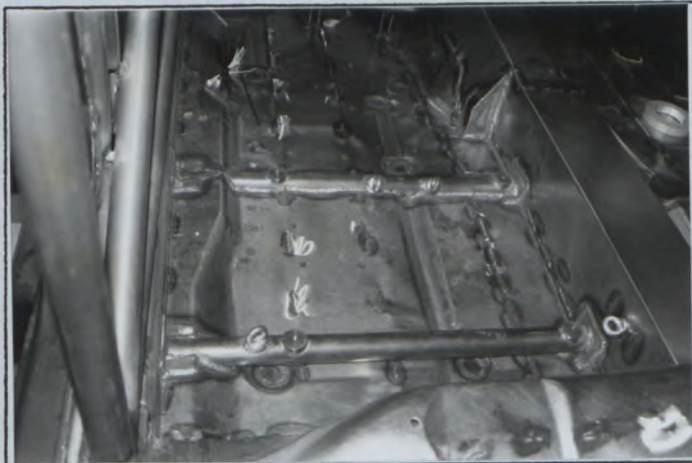

PHOTO No 10

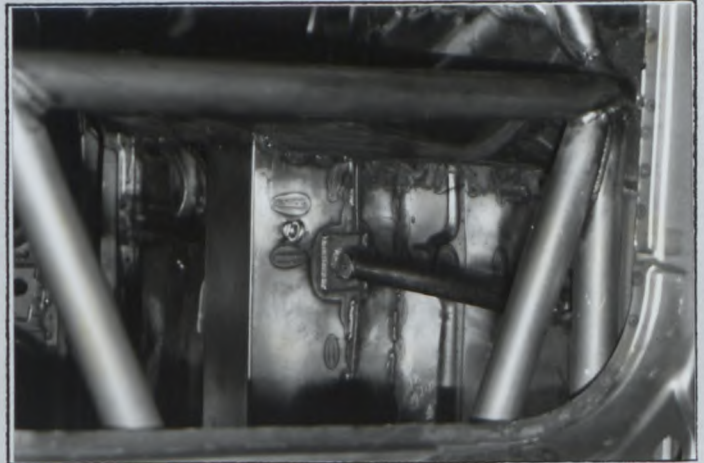

PHOTO No 11

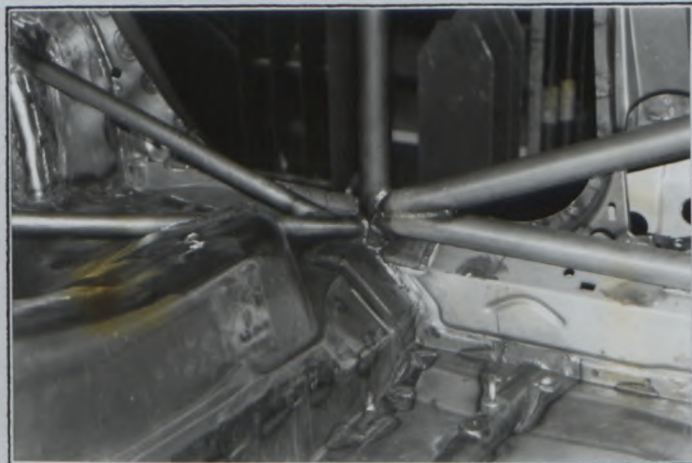
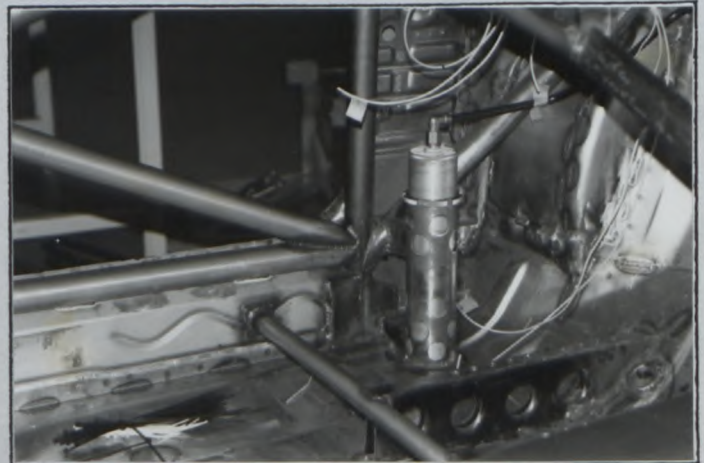

PHOTO No 12



**FEDERATION INTERNATIONALE  
DE L'AUTOMOBILE**

8, place de la Concorde, 75008 Paris

Services Administratifs :

8 bis. rue Boissy d'Anglas, 75008 Paris



Marque  
Make

Modèle  
Model

Homologation N°

**ST 27**

Extension N°

**06 / 0 4 V0**

PHOTO N°

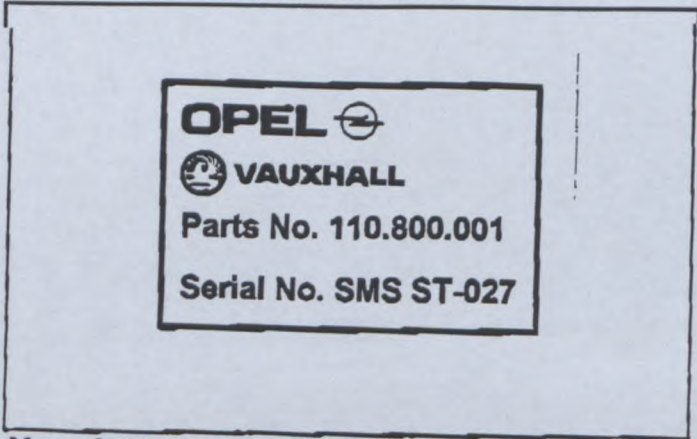

**Manufacturer Identification Label SMS ST-027**

PHOTO N°

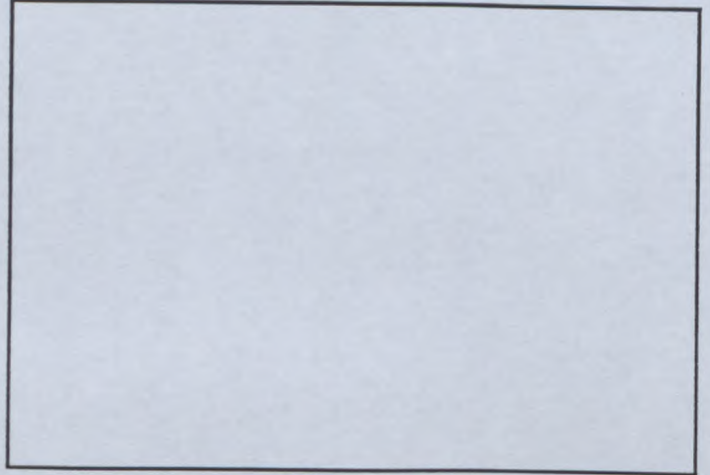

PHOTO N°

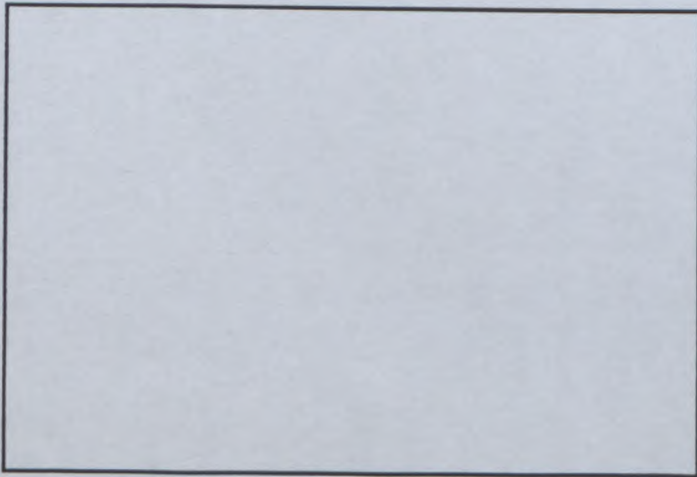

PHOTO N°

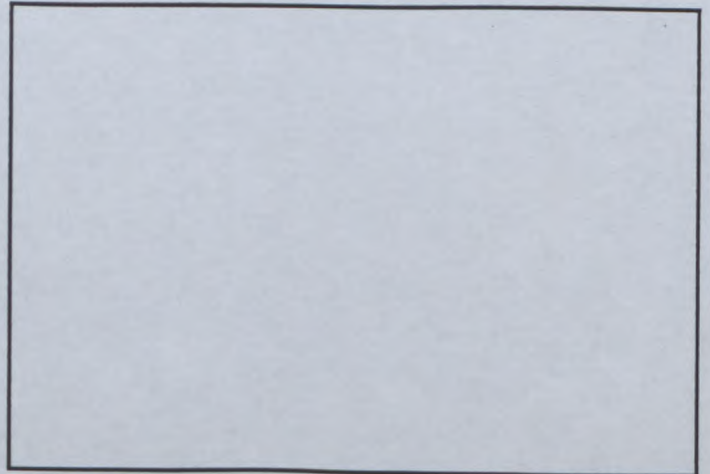

PHOTO N°

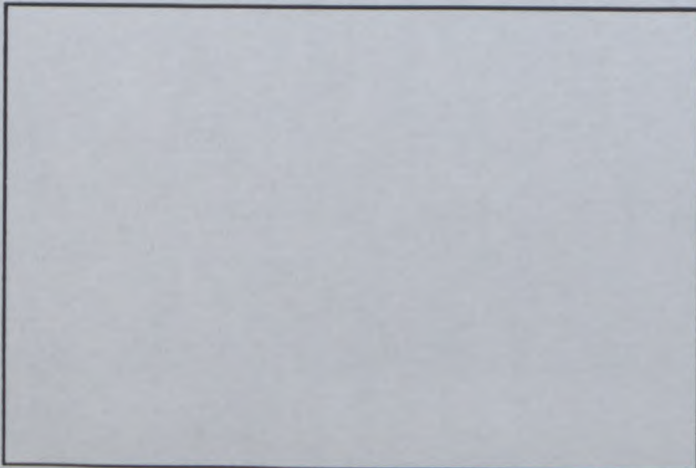
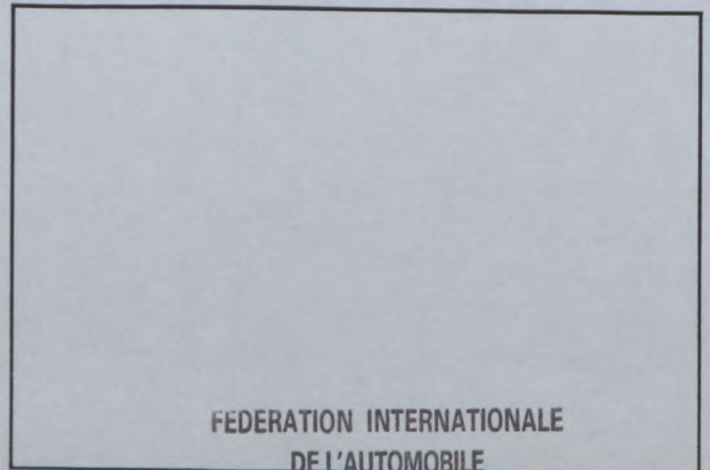

PHOTO N°



**FEDERATION INTERNATIONALE  
DE L'AUTOMOBILE**

8, place de la Concorde, 75008 Paris  
Services Administratifs :  
8 bis, rue Boissy d'Anglas, 75008 Paris





FEDERATION INTERNATIONALE  
DE L'AUTOMOBILE

Homologation No

**ST - 027**

Groupe  
Group

~~XXXXXXXXXX~~

Supertourisme  
Supertouring

Extension No

**07 / 05 VO**

FICHE D'EXTENSION D'HOMOLOGATION POUR ARMATURE DE SECURITE  
FORM OF HOMOLOGATION EXTENSION FOR SAFETY CAGE

**X** VO Variante option / Option variant

Véhicule: Constructeur Adam Opel AG Modèle et type OPEL / Vauxhall Vectra  
Vehicle: Manufactureur Adam Opel AG Model and type OPEL / Vauxhall Vectra

Homologation valable à partir du 01 MARS 1997  
Homologation valid as from \_\_\_\_\_

	Arceau principal Main rollbar	Entretoise longitudinale Longitudinal strut	Entretoise diagonale Diagonal Strut	Arceau avant Front rollbar
Matériau Material	<u>Steel</u>	<u>Steel</u>	<u>Steel</u>	<u>Steel</u>
Diamètre extérieur Exterior diameter	<u>38,1</u> mm	<u>38,1</u> mm	<u>38,1</u> mm	<u>38,1</u> mm
Epaisseur de paroi Wall thickness	<u>1,6</u> mm	<u>1,6</u> mm	<u>0,91</u> mm	<u>0,91</u> mm
Limite élastique Elastic limit	<u>650</u> N/mm <sup>2</sup>	<u>650</u> N/mm <sup>2</sup>	<u>650</u> N/mm <sup>2</sup>	<u>650</u> N/mm <sup>2</sup>
Résistance à la traction Tensile strength	<u>720-780</u> N/mm <sup>2</sup>	<u>720-780</u> N/mm <sup>2</sup>	<u>720-780</u> N/mm <sup>2</sup>	<u>720-780</u> N/mm <sup>2</sup>

All tubes are welded

Fabricant de l'armature SUPERPOWER ENGINEERING Poids total y compris les fixations 43.0 kg  
Structure manufacturer Total weight including fixations

Armature complète hors de la voiture  
Complete structure outside the car

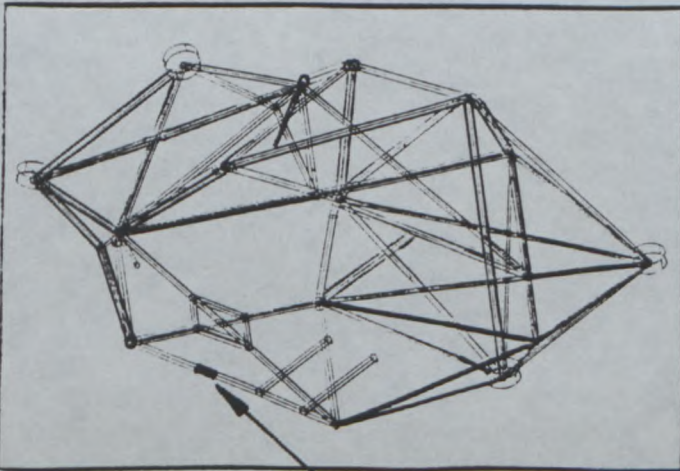

**SE-96 ST-027**

Nous attestons que la présente armature de sécurité répond aux dispositions de l'Annexe J de la FIA, en particulier en ce qui concerne ses implantations, ses connexions, et ses résistances aux contraintes.

We certify that the present safety structure complies with the conditions of the FIA Appendix J, in particular with its implantations, connections, and its stress resistances.

FEDERATION INTERNATIONALE  
DE L'AUTOMOBILE  
8, place de la Concorde, 75008 Paris  
Services Administratifs  
8 bis, rue de Valenciennes, 75008 Paris

Signature du représentant du constructeur du véhicule  
Signature of the car manufacturer representative

*[Signature]*  
W.P. Flohr







Marque / Make OPEL/VAUXHALL

Modèle / Model VECTRA

Homologation No

**ST 27**

Extension No

**07/05V0**

PHOTO No 7



PHOTO No 8

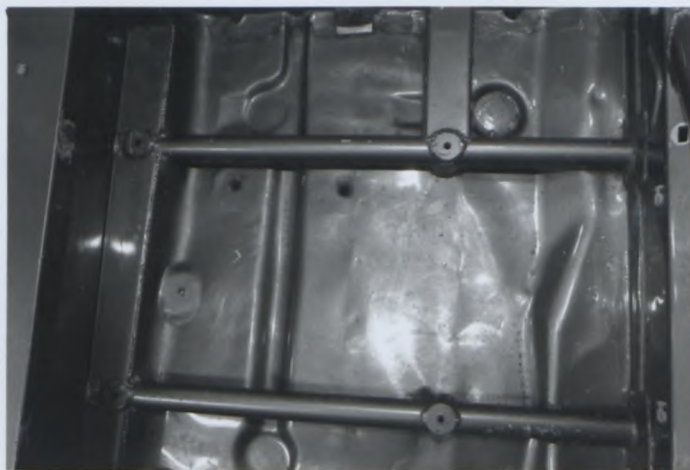

PHOTO No 9



PHOTO No 10



PHOTO No 11



PHOTO No 12



**FERRAZZI INTERNATIONAL**

**DE L'AUTOMOBILE**

8, place de la Concorde, 75008 Paris

Services Administratifs :

8 bis, rue Boissy d'Anglas, 75008 Paris



Marque **Adam Opel AG**  
Make

Modèle **OPEL / Vauxhall Vectra**  
Model

Homologation No  
**ST - 027**

Extension No  
**07 / 0 5 VO**

PHOTO No **13**

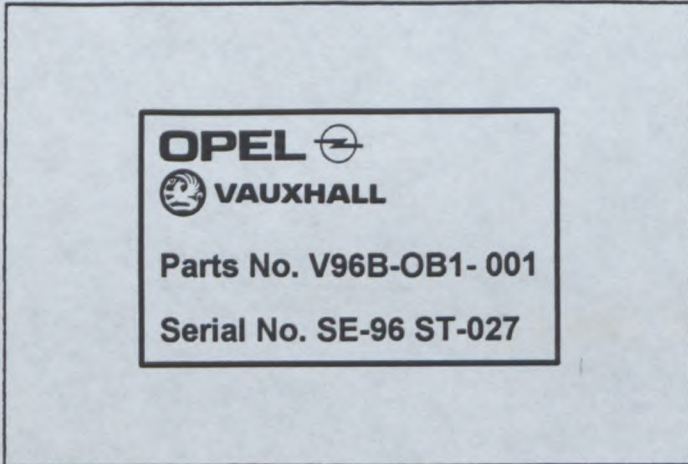

**Manufacturer Identificat. Label SE-96 ST-027**

PHOTO No

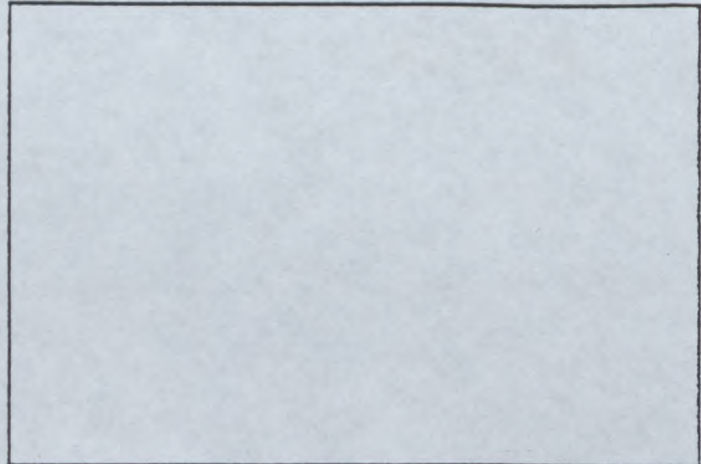

PHOTO No

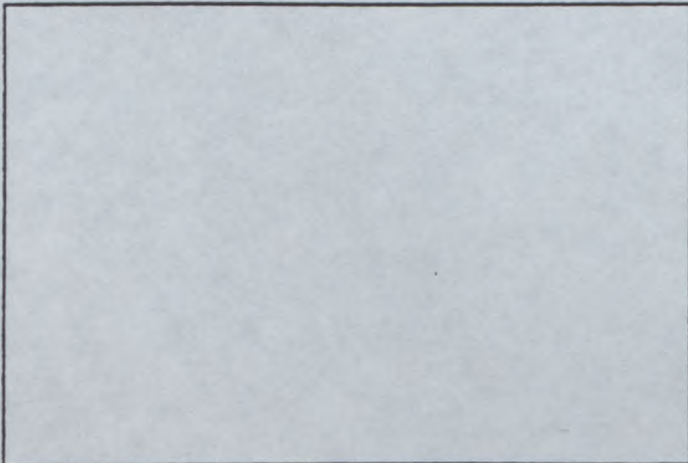

PHOTO No

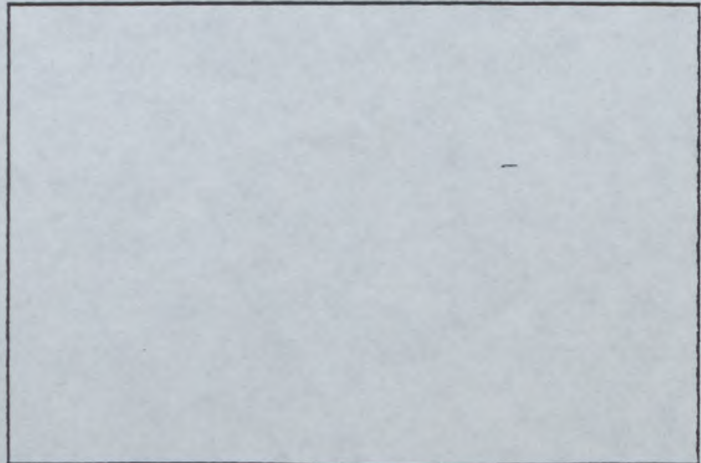

PHOTO No

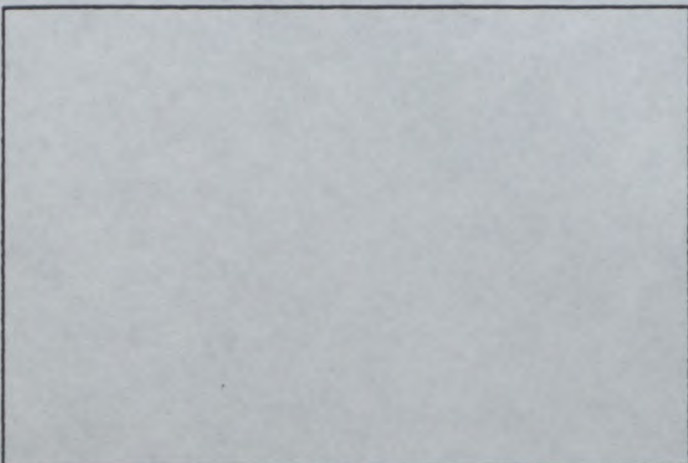
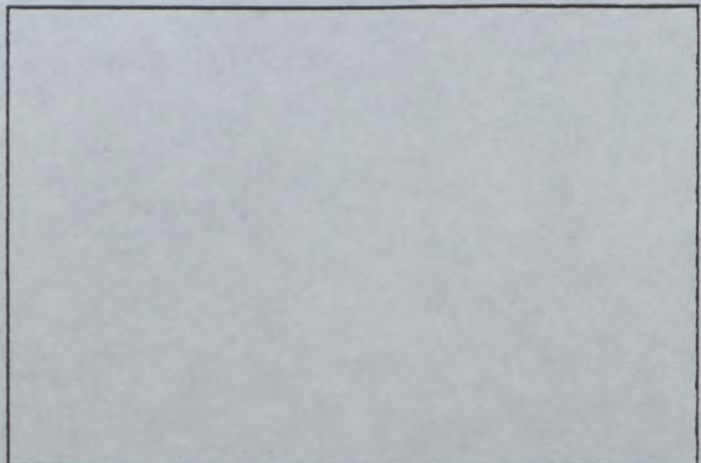

PHOTO No



**FEDERATION INTERNATIONALE  
DE L'AUTOMOBILE**

8, place de la Concorde, 75008 Paris

Services Administratifs :

8 bis, rue Boissy d'Anglas, 75008 Paris





FEDERATION INTERNATIONALE DE L'AUTOMOBILE

Homologation N°

ST - 27

Extension N°

08/06 VO

VO

Adam Opel AG

Opel / Vauxhall Vectra B

FICHE D'EXTENSION D'HOMOLOGATION POUR DISPOSITIFS AERODYNAMIQUES EN SUPERTOURISME  
HOMOLOGATION EXTENSION FORM FOR AERODYNAMIC DEVICES IN SUPER TOURING

Homologation valable à partir du  
Homologation valid as from

01 MARS 1997

A) Voiture vue de 3/4 avant  
Car seen from 3/4 front

B) Voiture vue de 3/4 arrière  
Car seen from 3/4 rear



9. CARROSSERIE / BODYWORK

XVI) DISPOSITIF AVANT DEPOSE ET VU DE FACE AVEC DIMENSIONS DES OUVERTURES :  
DISMOUNTED FRONT DEVICE SEEN FROM FRONT WITH DIMENSIONS OF OPENINGS:

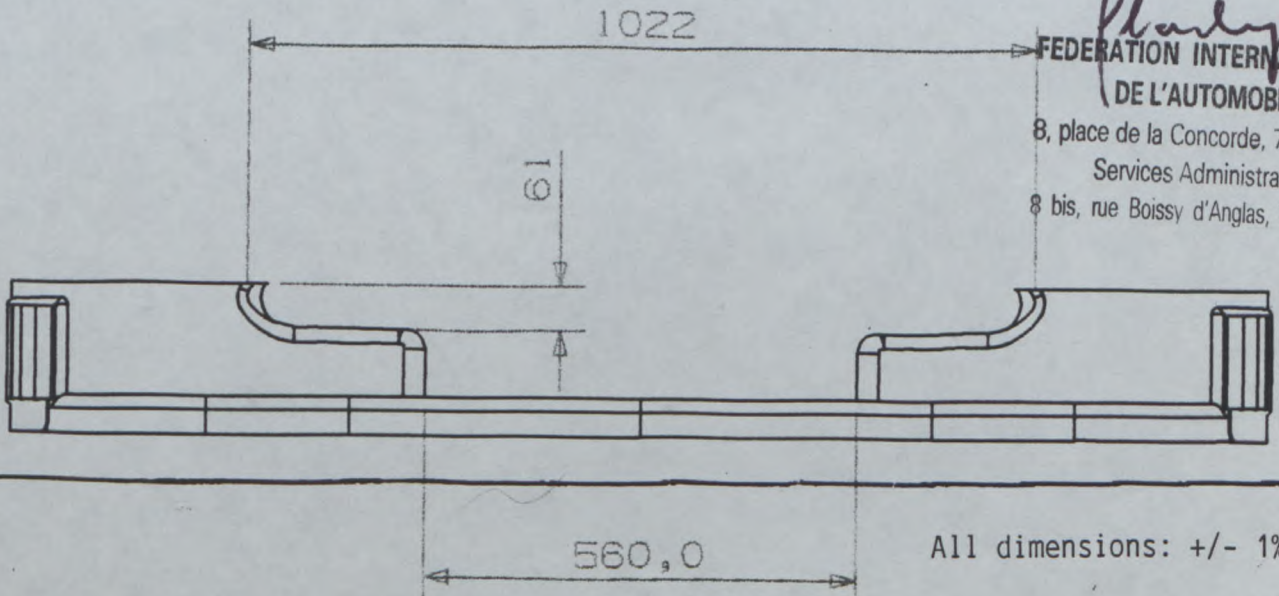

*Charly*  
FEDERATION INTERNATIONALE DE L'AUTOMOBILE  
8, place de la Concorde, 75008 Paris  
Services Administratifs :  
8 bis, rue Boissy d'Anglas, 75008 Paris

All dimensions: +/- 1%



Marque Adam Opel AG  
Make

Modèle Opel / Vauxhall Vectra B  
Model

Homologation N°

ST - 27

Extension N°

08/06V0

XVIII) DISPOSITIF AVANT DEPOSE ET VU DE COTE AVEC DIMENSIONS DES OUVERTURES :  
DISMOUNTED FRONT DEVICE IN SIDE VIEW WITH DIMENSIONS OF OPENINGS:



XXIII) DISPOSITIF AVANT EN PLACE ET VU DE FACE :  
MOUNTED FRONT DEVICE SEEN FROM FRONT:



XXIV) DISPOSITIF AVANT EN PLACE ET VU DE COTE :  
MOUNTED FRONT DEVICE IN SIDE VIEW:



FEDERATION INTERNATIONALE  
DE L'AUTOMOBILE

8, place de la Concorde, 75008 Paris

Service Administratif :

8 bis, rue Boissy d'Anglas, 75008 Paris



Marque Adam Opel AG  
Make

Modèle Opel / Vauxhall Vectra B  
Model

Homologation N°

ST - 27

Extension N°

08/06 VO

XVII) DISPOSITIF ARRIERE EN PLACE  
ET VU DE COTE :  
MOUNTED REAR DEVICE IN SIDE VIEW:



XIX) SECTION DU DISPOSITIF ARRIERE AU  
NIVEAU DE L'AXE LONGITUDINAL DE LA  
VOITURE :  
SECTION OF REAR DEVICE AT CAR'S  
CENTERLINE LEVEL:

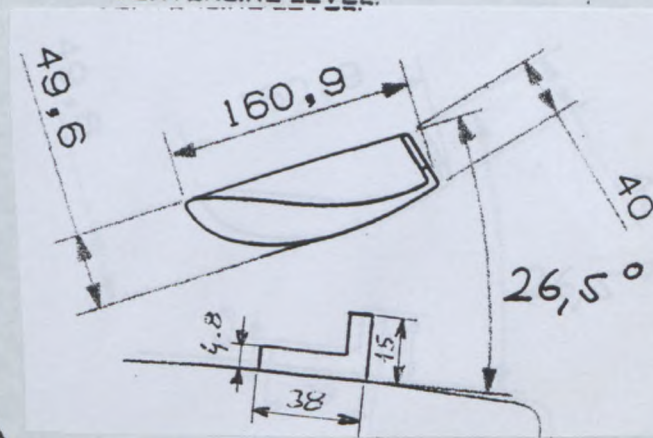

XX) DISPOSITIF ARRIERE EN PLACE ET VU DE DESSUS :  
MOUNTED REAR DEVICE SEEN FROM ABOVE:



XXI) DISPOSITIF ARRIERE DEPOSE ET  
VU DE COTE :  
DISMOUNTED REAR DEVICE IN SIDE VIEW:

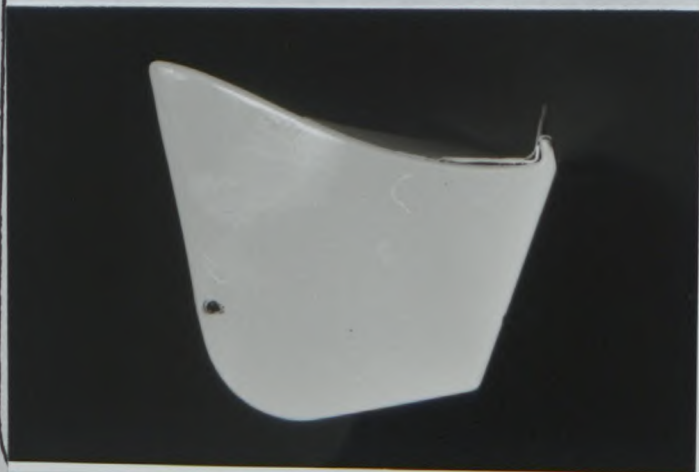

All dimensions: +/- 1%

FEDERATION INTERNATIONALE  
DE L'AUTOMOBILE

8, place de la Concorde, 75008 Paris

Services Administratifs :

8 bis, rue Boissy d'Angas, 75008 Paris



Marque / Make: Adam Opel AG

Modèle / Model: Opel / Vauxhall Vectra B

Homologation N°:

ST - 27

Extension N°:

08 / 06 V0

XXII) DISPOSITIF ARRIERE DEPOSE ET VU DE DESSUS :  
DISMOUNTED REAR DEVICE SEEN FROM ABOVE:

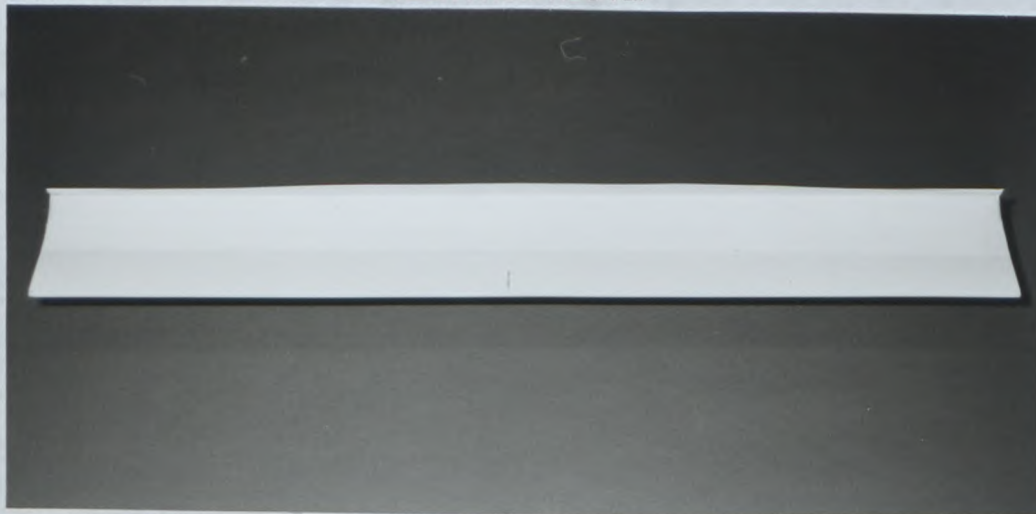

902. Extérieur : p) Angle entre dispositif arrière et carrosserie 26,5°  
Exterior: Angle between rear device and bodywork

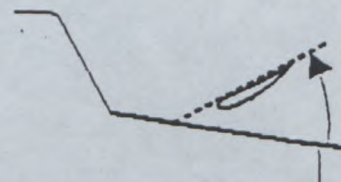

INFORMATIONS COMPLEMENTAIRES / COMPLEMENTARY INFORMATION :

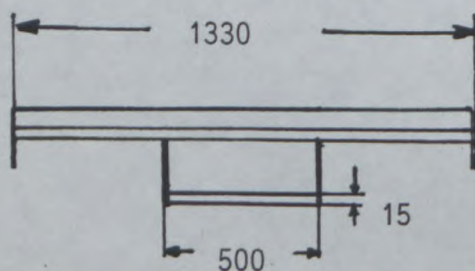
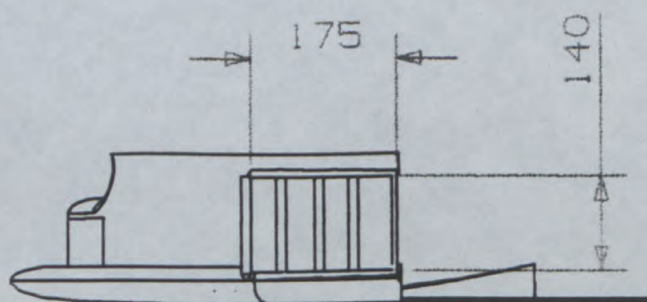

FEDERATION INTERNATIONALE  
DE L'AUTOMOBILE

8, place de la Concorde, 75008 Paris  
Services Administratifs :  
8 bis, rue Boissy d'Anglas, 75008 Paris

all dimensions: +/- 1%





FEDERATION INTERNATIONALE DU SPORT AUTOMOBILE

Homologation Nr. Homologation No.

ST-027

ONS

Oberste Nationale Sportkommission für den Automobilsport in Deutschland GmbH

Nachtrag Nr. Extension No.

09/03 ER

Gruppe Group ~~AV/B/N/K/T/A~~

SUPER TOURING CARS

Nachtrag zum Homologationsblatt Form of homologation extension



ES Sportevolution des Typs Sporting evolution of the type



VO Ausstattungsvariante Option variant



ET Normale Evolution des Typs Normal evolution of the type



ER Berichtigung Erratum



VF Liefervariante Supply variant

Fahrzeughersteller: Adam Opel AG Vehicle Manufacturer

Modell und Typ: OPEL / Vauxhall Vectra Model and Type

Homologation gültig ab: 01 AVR. 1997 Homologation valid as from

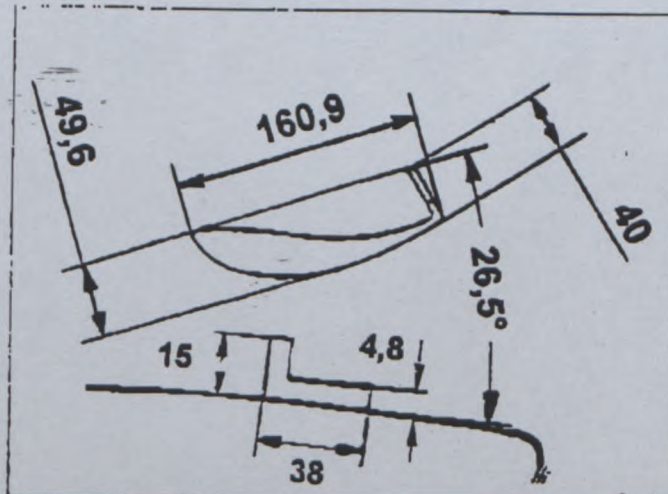
Seite oder Nachtrag Page or extension	Artikel Article	Beschreibung Description
08 / 06 VO		<p><b>XIX) Section of rear device at car's centerline level: Bracket in the drawing is the wrong way round</b></p> <p><b>Replace the drawing at extension 08 / 06 VO on page 3 with the following one:</b></p> 

*Handwritten signature*  
 FEDERATION INTERNATIONALE DE L'AUTOMOBILE  
 8, place de la Concorde, 75008 Paris  
 Services Administratifs :  
 8 bis, rue Boissy d'Anglas, 75008 Paris





# FEDERATION INTERNATIONALE DE L'AUTOMOBILE

Homologation N°

ST 027

Group **Supertourisme / Supertouring**

Extension N°

10 / 07 VO

## FICHE D'EXTENSION D'HOMOLOGATION POUR ARMATURE DE SECURITE FORM OF HOMOLOGATION EXTENSION FOR SAFETY CAGE

 VO Variante option / Option variant

Véhicule : Constructeur  
Vehicle : Manufacturer **ADAM OPEL AG**

Modèle et type  
Model and type **OPEL / VAUXHALL VECTRA**

Homologation valable à partir du  
Homologation valid as from **01 MARS 1998**

	Arceau principal Main rollbar	Entretoise longitudinale Longitudinal strut	Entretoise diagonale Diagonal strut	Arceau avant Front rollbar
Matériau Material	T45 Steel	T45 Steel	T45 Steel	T45 Steel
Diamètre extérieur Exterior diameter	44.45 mm	76.20 mm	44.45 mm	76.20 mm
Epaisseur de paroi Wall thickness	1.20 mm	1.00 mm	1.20 mm	1.00 mm
Limite élastique Elastic limit	65 daN/mm <sup>2</sup>	65 daN/mm <sup>2</sup>	65 daN/mm <sup>2</sup>	65 daN/mm <sup>2</sup>
Résistance à la traction Tensile strength	75 daN/mm <sup>2</sup>	75 daN/mm <sup>2</sup>	75 daN/mm <sup>2</sup>	75 daN/mm <sup>2</sup>

Fabricant de l'armature  
Structure manufacturer **TRIPLE EIGHT RACE ENGINEERING**

Poids total y compris les fixations  
Total weight including fixations **51.8** kg

Arceau soudé  
Welded rollbar

oui / yes  non / no

Armature complète hors de la voiture  
Complete structure outside the car (Indiquer par une flèche la position de la plaque d'identification)  
(Indicate the position of the identification plate with an arrow)

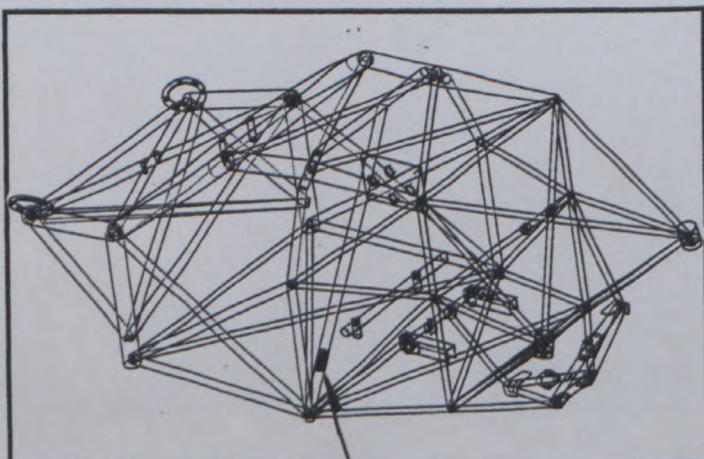

Nous attestons que la présente armature de sécurité répond aux dispositions de l'Annexe J de la FIA, en particulier en ce qui concerne ses implantations, ses connexions, et ses résistances aux contraintes.

We certify that the present safety structure complies with the conditions of the FIA Appendix J, in particular with regard to its attachments, its connections, and its stress resistances.

John Gentry

Nom et signature du représentant du constructeur du véhicule  
Name and signature of the car manufacturer representative

FEDERATION INTERNATIONALE  
DE L'AUTOMOBILE

8, place de la Concorde, 75008 Paris

Services Administratifs :

8 bis, rue Boissy d'Anglas, 75008 Paris



ST 027

10/07V0

Marque  
Make **ADAM OPEL AG**

Modèle  
Model **OPEL /VAUHALL VECTRA**

PHOTO montrant l'identification du constructeur et le numéro de série de l'arceau.

PHOTO showing the manufacturer's identification and the series number of the rollbar.



PHOTO N° 1/98

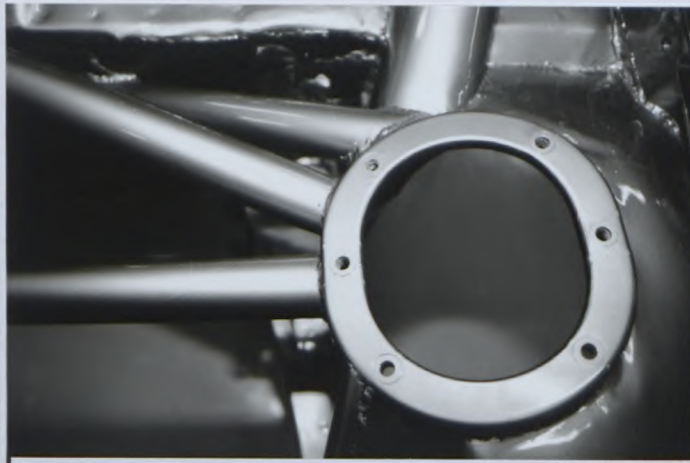

PHOTO N° 2/98

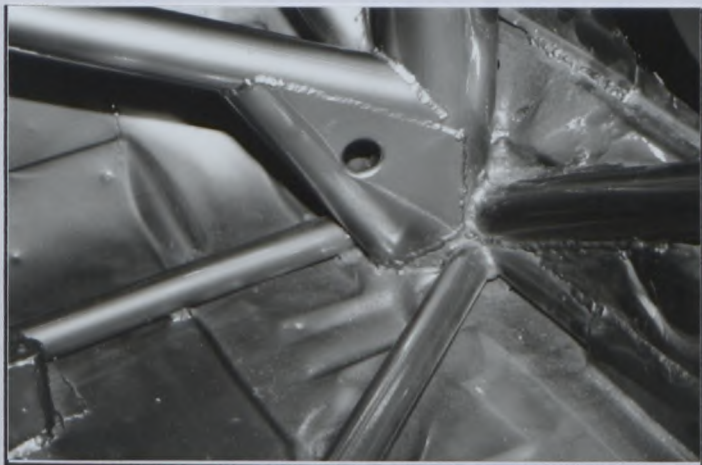

PHOTO N° 3/98

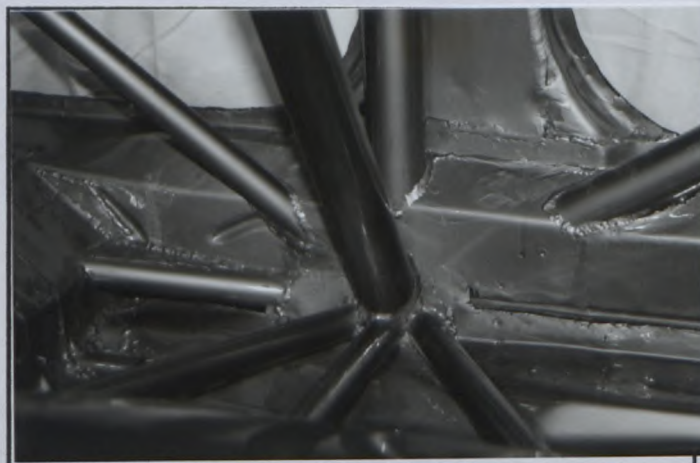
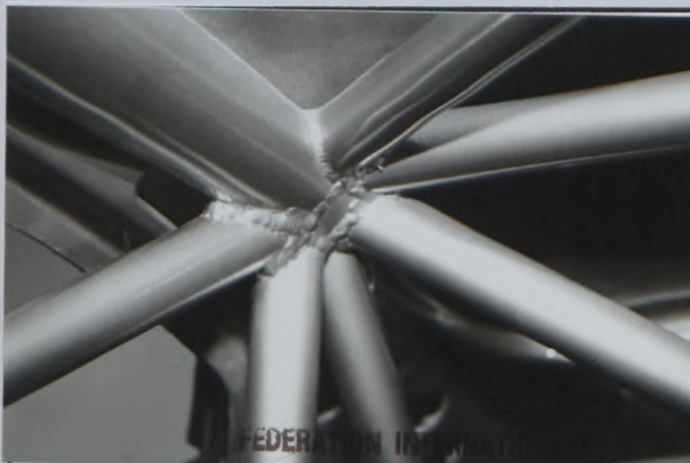

PHOTO N° 4/98



PHOTO N° 5/98



FEDERATION INTERNATIONALE  
DE L'AUTOMOBILE

8, place de la Concorde, 75008 Paris  
Services Administratifs :  
8 bis, rue Boissy d'Anglas, 75008 Paris



ST 027

10/07V0

Marque  
Make **ADAM OPEL AG**

Modèle  
Model **OPEL VAUXHALL VECTRA**

PHOTO N° 6/98

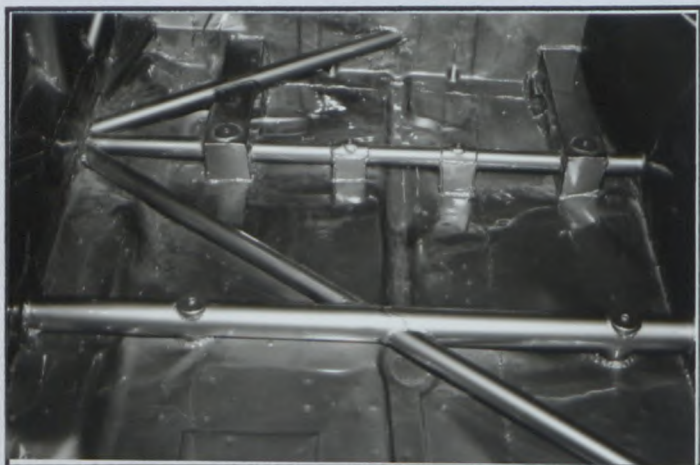

PHOTO N° 7/98

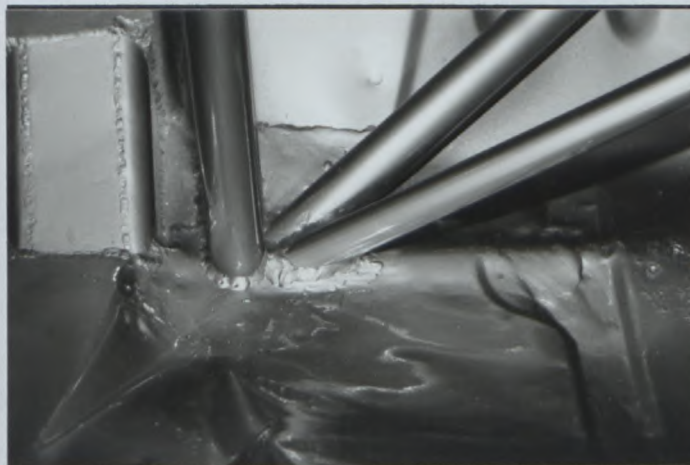

PHOTO N° 8/98



PHOTO N° 9/98



PHOTO N° 10/98

*verif*



PHOTO N° 11/98



FEDERATION INTERNATIONALE  
DE L'AUTOMOBILE  
8, place de la Concorde, 75008 Paris  
Services Administratifs :  
8 bis, rue Boissy d'Anglas, 75008 Paris



Marque  
Make **ADAM OPEL AG**

Modèle  
Model **OPEL VAUXHALL VECTRA**

**ST 027**

**10/07V0**

Article	Description
	<b><u>SAFETY CAGE MOUNTINGS</u></b>
	<b><u>V 98 OB1 009 / 888 - 98 ST 027</u></b>
<b><u>Photo</u></b>	
<b><u>1/98</u></b>	<b><u>Front Strut</u></b>
<b><u>2/98</u></b>	<b><u>"A" Post / Floor</u></b>
<b><u>3/98</u></b>	<b><u>"B" Post / Floor</u></b>
<b><u>4/98</u></b>	<b><u>Rear Turret</u></b>
<b><u>5/98</u></b>	<b><u>"C" Post / Roof</u></b>
<b><u>6/98</u></b>	<b><u>Floor / Seat Rails</u></b>
<b><u>7/98</u></b>	<b><u>"C" Post / Floor</u></b>
<b><u>8/98</u></b>	<b><u>"A" Post / Dashboard</u></b>
<b><u>9/98</u></b>	<b><u>"B" Post / Roof</u></b>
<b><u>10/98</u></b>	<b><u>"A" Post / Windscreen</u></b>
<b><u>11/98</u></b>	<b><u>Front Baulkhead</u></b>

**FEDERATION INTERNATIONALE  
DE L'AUTOMOBILE**  
8, place de la Concorde, 75008 Paris  
Services Administratifs :  
8 bis, rue Boissy d'Anglas, 75008 Paris





FEDERATION INTERNATIONALE  
DE L'AUTOMOBILE

Homologation N°

ST - 027

Group **Supertourisme / Supertouring**

Extension N°

11 / 08 VO

FICHE D'EXTENSION D'HOMOLOGATION POUR ARMATURE DE SECURITE  
FORM OF HOMOLOGATION EXTENSION FOR SAFETY CAGE

**VO** Variante option / Option variant

Véhicule : Constructeur  
Vehicle : Manufacturer **ADAM OPEL AG**

Modèle et type  
Model and type **OPEL VECTRA B**

Homologation valable à partir du  
Homologation valid as from

01 AVR. 1998

	Arceau principal Main rollbar	Entretoise longitudinale Longitudinal strut	Entretoise diagonale Diagonal strut	Arceau avant Front rollbar
Matériau Material	Stahl / Steel	Stahl / Steel	Stahl / Steel	Stahl / Steel
Diamètre extérieur Exterior diameter	38.1 mm	30 mm	38.1 mm	38.1 mm
Épaisseur de paroi Wall thickness	1.6 mm	1.0 mm	0.9 mm	1.6 mm
Limite élastique Elastic limit	70 daN/mm <sup>2</sup>	70 daN/mm <sup>2</sup>	70 daN/mm <sup>2</sup>	70 daN/mm <sup>2</sup>
Résistance à la traction Tensile strength	80 daN/mm <sup>2</sup>	80 daN/mm <sup>2</sup>	80 daN/mm <sup>2</sup>	80 daN/mm <sup>2</sup>

Fabricant de l'armature  
Structure manufacturer **SMS AG**

Poids total y compris les fixations  
Total weight including fixations **53** kg

Arceau soudé  
Welded rollbar

<input checked="" type="checkbox"/> oui yes	<input type="checkbox"/> non no
------------------------------------------------	------------------------------------

Armature complète hors de la voiture (Indiquer par une flèche la position de la plaque d'identification)  
Complete structure outside the car (Indicate the position of the identification plate with an arrow)

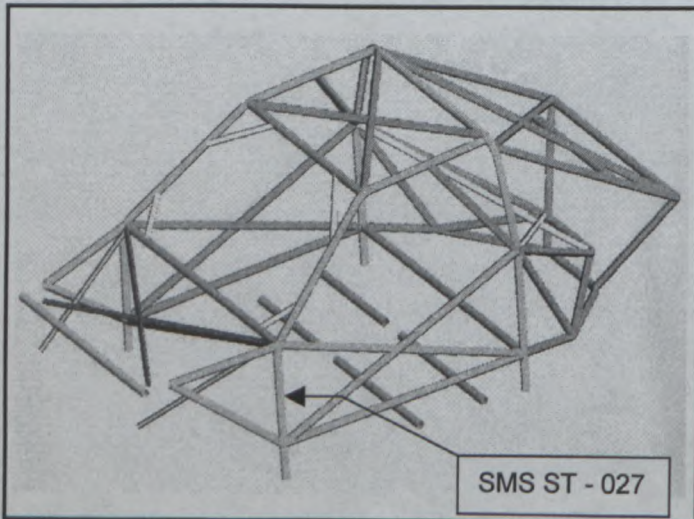

Nous attestons que la présente armature de sécurité répond aux dispositions de l'Annexe J de la FIA, en particulier en ce qui concerne ses implantations, ses connexions, et ses résistances aux contraintes.

We certify that the present safety structure complies with the conditions of the FIA Appendix J, in particular with regard to its attachments, its connections, and its stress resistances.

Nom et signature du représentant du constructeur du véhicule  
Name and signature of the car manufacturer representative

*Donatus Wichelhaus*  
Donatus Wichelhaus

FEDERATION INTERNATIONALE  
DE L'AUTOMOBILE

8 place de la Concorde, 75008 Paris  
Services Administratifs :  
8 bis, rue Boissy d'Anglas, 75008 Paris



Marque  
Make **ADAM OPEL AG**

Modèle  
Model **OPEL VECTRA B**

**ST - 027**

**11/08V0**

PHOTO montrant l'identification du constructeur et le numéro de série de l'arceau.

PHOTO showing the manufacturer's identification and the series number of the rollbar.



PHOTO N° 1

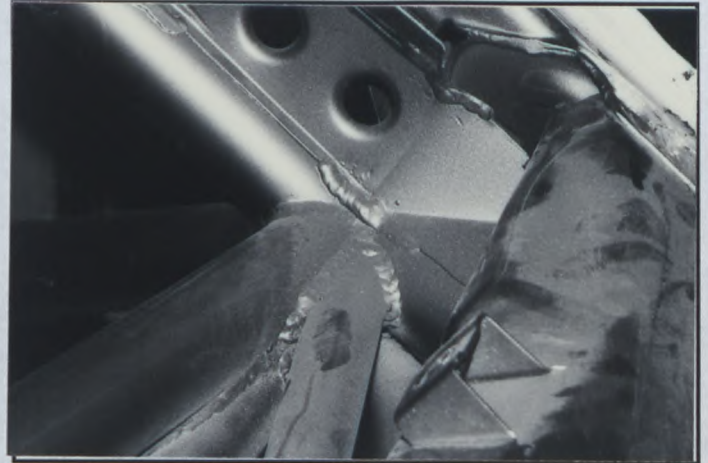

PHOTO N° 2

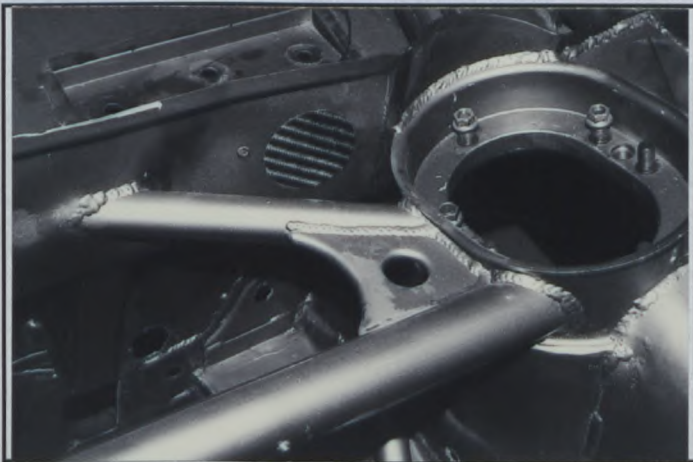

PHOTO N° 3



PHOTO N° 4



PHOTO N° 5



FÉDÉRATION INTERNATIONALE  
DE L'AUTOMOBILE

8, place de la Concorde, 75008 Paris

Services Administratifs :

8 bis, rue Boissy d'Anglas, 75008 Paris



**ST - 027**

**11/08VO**

Marque  
Make **ADAM OPEL AG**

Modèle  
Model **OPEL VECTRA B**

PHOTO N° 6

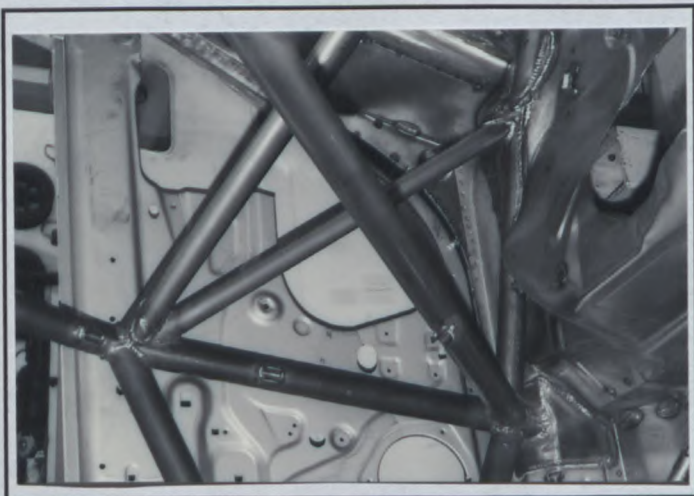

PHOTO N° 7

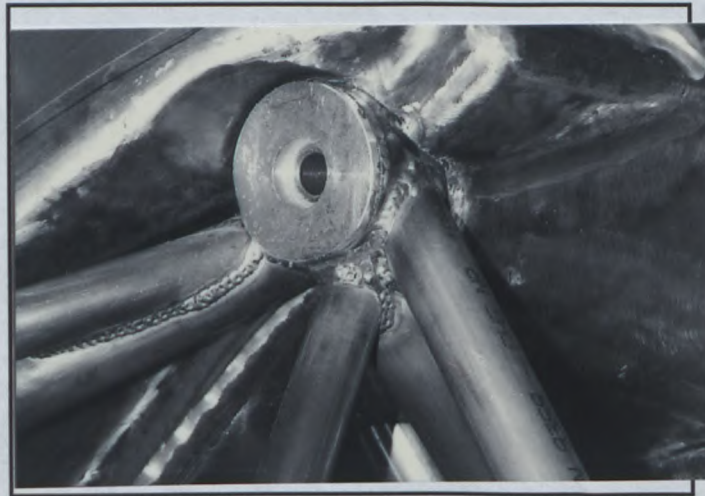

PHOTO N° 8

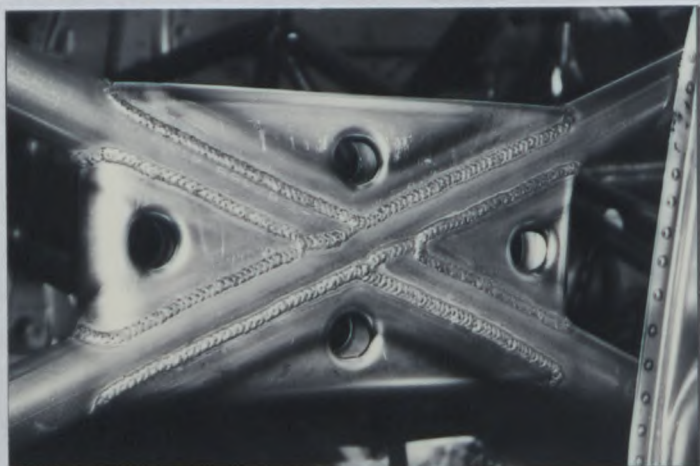

PHOTO N° 9

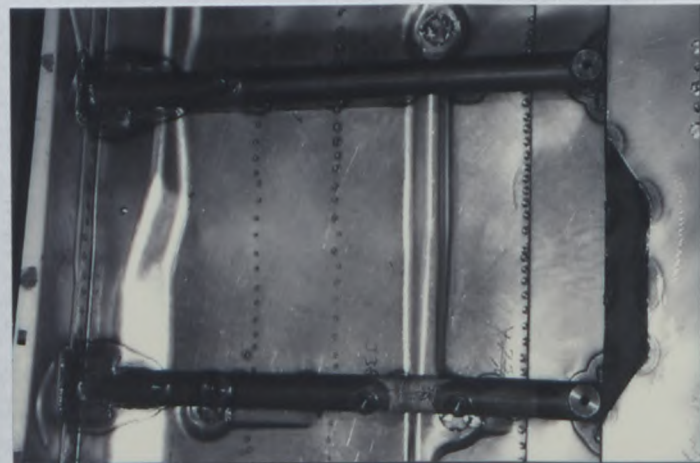

PHOTO N° 10

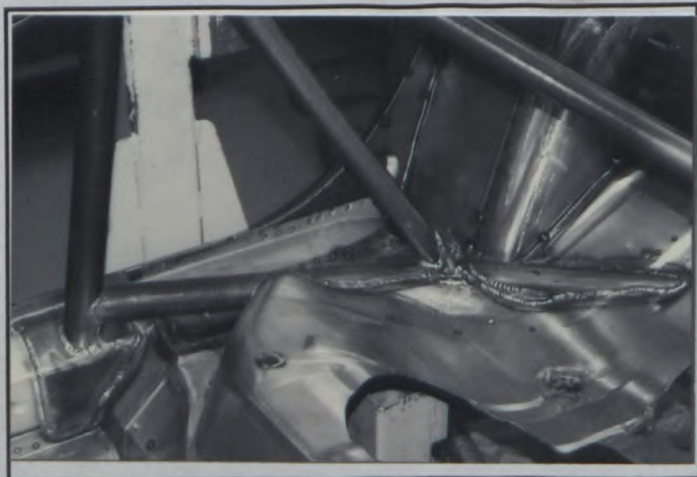

PHOTO N° 11

FEDERATION INTERNATIONALE  
DE L'AUTOMOBILE  
8, place de la Concorde, 75008 Paris  
Services Administratifs :  
8 bis, rue Boissy d'Anglas, 75008 Paris





FEDERATION INTERNATIONALE  
DE L'AUTOMOBILE

Homologation N°

ST - 027

Group **Supertourisme / Supertouring**

Extension N°

12 / 09 VO

FICHE D'EXTENSION D'HOMOLOGATION POUR ARMATURE DE SECURITE  
FORM OF HOMOLOGATION EXTENSION FOR SAFETY CAGE

**VO** Variante option / Option variant

Véhicule : Constructeur  
Vehicle : Manufacturer **ADAM OPEL AG**

Modèle et type  
Model and type **OPEL VECTRA B**

Homologation valable à partir du  
Homologation valid as from **01 AVR. 1998**

	Arceau principal Main rollbar	Entretoise longitudinale Longitudinal strut	Entretoise diagonale Diagonal strut	Arceau avant Front rollbar
Matériau Material	<b>Stahl / Steel</b>	<b>Stahl / Steel</b>	<b>Stahl / Steel</b>	<b>Stahl / Steel</b>
Diamètre extérieur Exterior diameter	<b>38.1 mm</b>	<b>25.4 mm</b>	<b>38.1 mm</b>	<b>38.1 mm</b>
Épaisseur de paroi Wall thickness	<b>1.6 mm</b>	<b>1.0 mm</b>	<b>0.9 mm</b>	<b>1.6 mm</b>
Limite élastique Elastic limit	<b>70 daN/mm<sup>2</sup></b>	<b>70 daN/mm<sup>2</sup></b>	<b>70 daN/mm<sup>2</sup></b>	<b>70 daN/mm<sup>2</sup></b>
Résistance à la traction Tensile strength	<b>80 daN/mm<sup>2</sup></b>	<b>80 daN/mm<sup>2</sup></b>	<b>80 daN/mm<sup>2</sup></b>	<b>80 daN/mm<sup>2</sup></b>

Fabricant de l'armature  
Structure manufacturer **SMS AG**

Poids total y compris les fixations  
Total weight including fixations **52** kg

Arceau soudé  
Welded rollbar

oui  
yes  non  
no

Armature complète hors de la voiture  
Complete structure outside the car (Indiquer par une flèche la position de la plaque d'identification)  
(Indicate the position of the identification plate with an arrow)

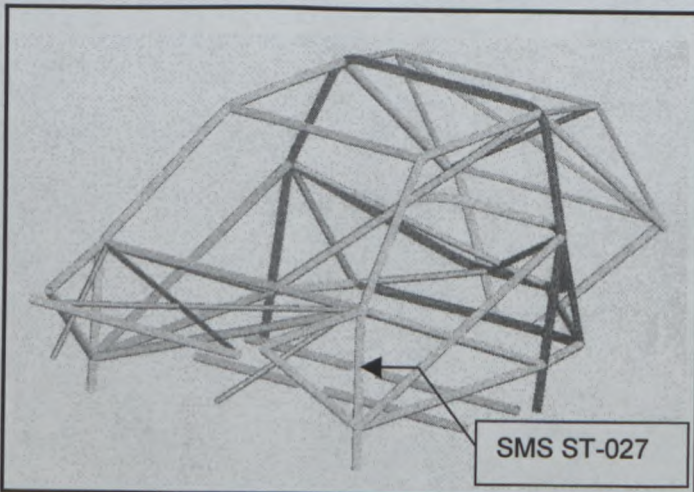

Nous attestons que la présente armature de sécurité répond aux dispositions de l'Annexe J de la FIA, en particulier en ce qui concerne ses implantations, ses connexions, et ses résistances aux contraintes.

We certify that the present safety structure complies with the conditions of the FIA Appendix J, in particular with regard to its attachments, its connections, and its stress resistances.

Nom et signature du représentant du constructeur du véhicule  
Name and signature of the car manufacturer representative

*Donatus Wicher*

Donatus Wicher

FEDERATION INTERNATIONALE  
DE L'AUTOMOBILE

8, place de la Concorde, 75008 Paris

Services Administratifs :

8 bis, rue Boissy d'Anglas, 75008 Paris



**ST - 027**

**12/09 VO**

Marque  
Make **ADAM OPEL AG**

Modèle  
Model **OPEL VECTRA B**

PHOTO montrant l'identification du constructeur et le numéro de série de l'arceau.

PHOTO showing the manufacturer's identification and the series number of the rollbar.



PHOTO N° 1



PHOTO N° 2



PHOTO N° 3



PHOTO N° 4

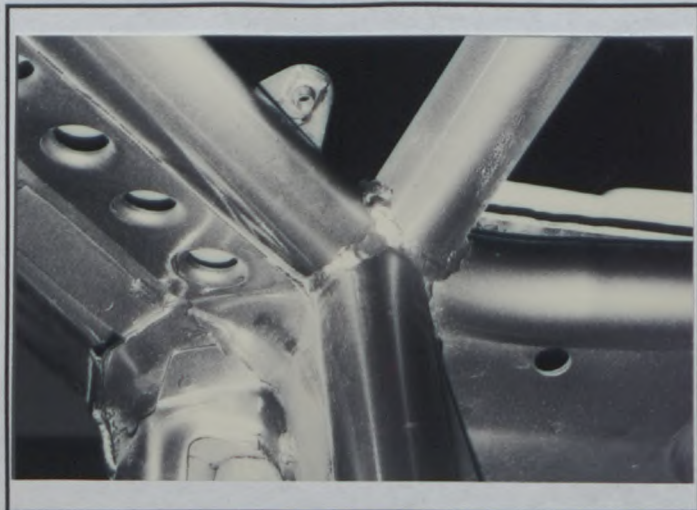

PHOTO N° 5



**FEDERATION INTERNATIONALE  
DE L'AUTOMOBILE**

8, place de la Concorde, 75008 Paris  
Services Administratifs :  
8 bis, rue Boissy d'Anglas, 75008 Paris



Marque  
Make **ADAM OPEL AG**

Modèle  
Model **OPEL VECTRA B**

Homologation N°

**ST - 027**

Extension N°

**12 / 0 9 V0**

PHOTO N° 6



PHOTO N° 7

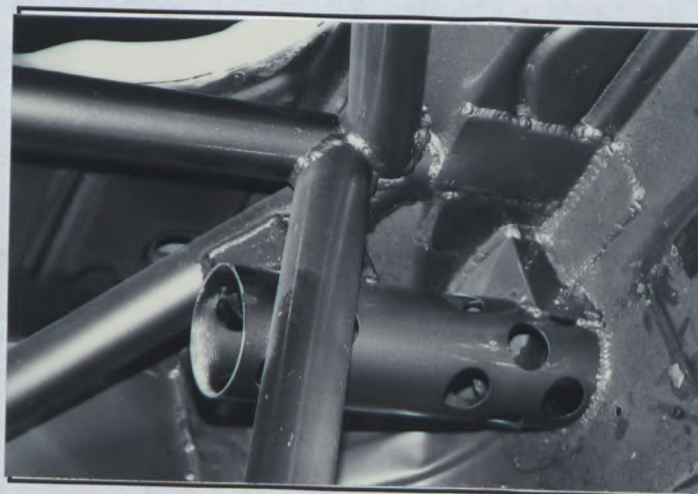

PHOTO N° 8

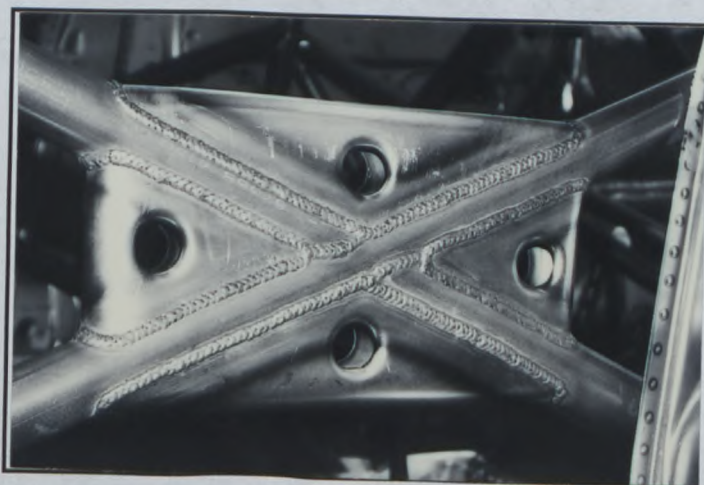

PHOTO N° 9



PHOTO N° 10

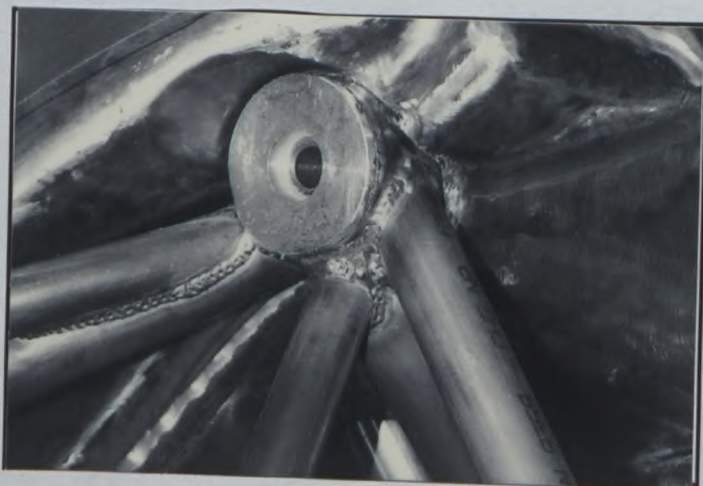
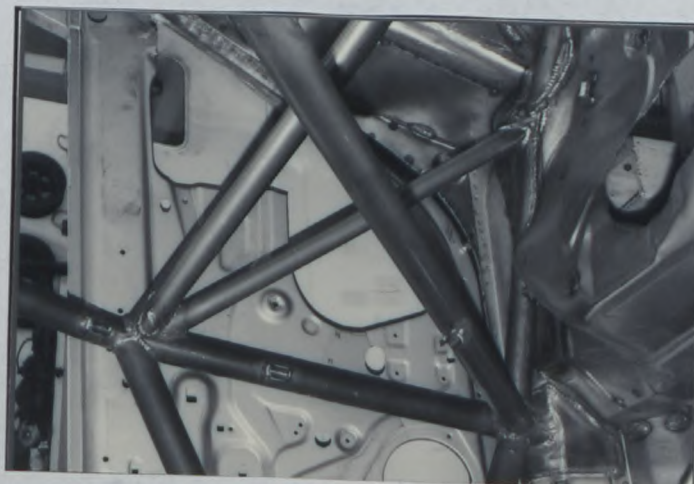

PHOTO N° 11



**FEDERATION INTERNATIONALE  
DE L'AUTOMOBILE**

8, place de la Concorde, 75008 Paris  
Services Administratifs :

8 bis rue Boissy d'Anglas, 75008 Paris



Marque  
Make **ADAM OPEL AG**

Modèle  
Model **OPEL VECTRA B**

Homologation N°

**ST - 027**

Extension N°

**12 / 0 9 V 0**

PHOTO N° 12

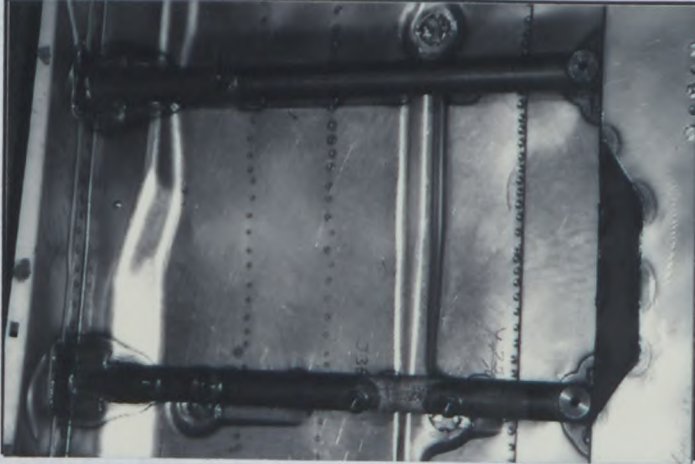

PHOTO N°

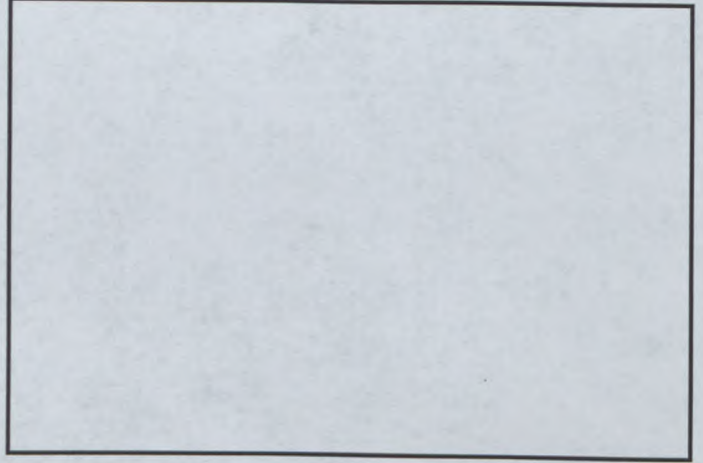

PHOTO N°

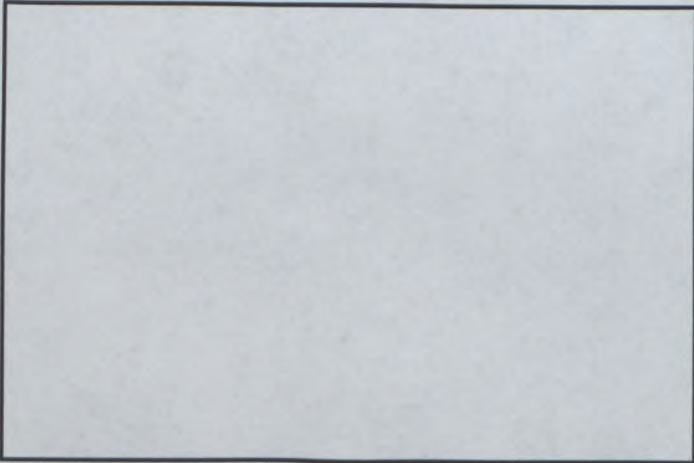

PHOTO N°

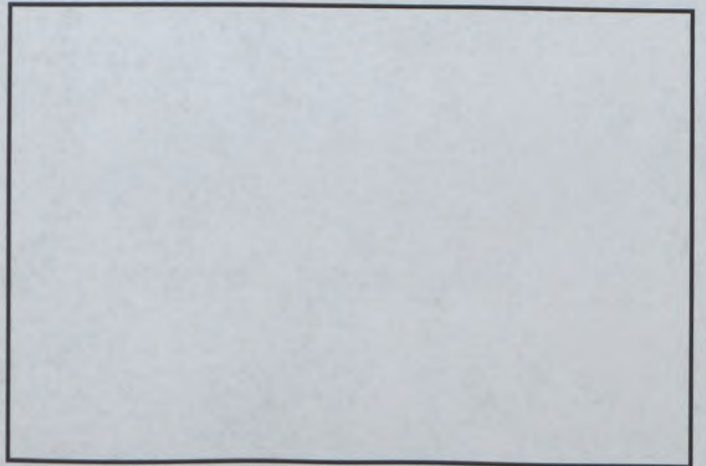

PHOTO N°

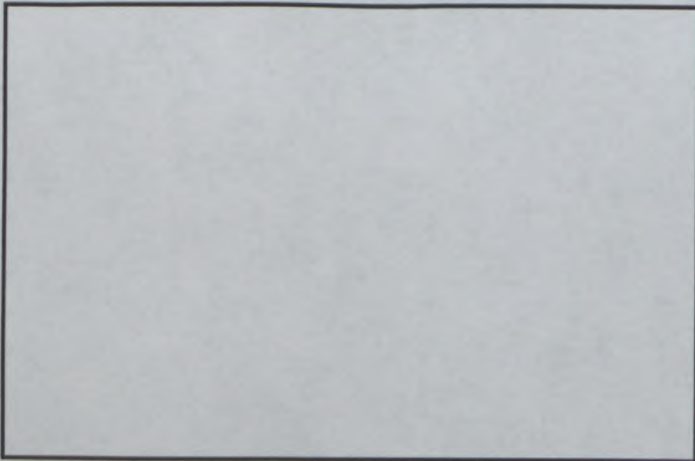
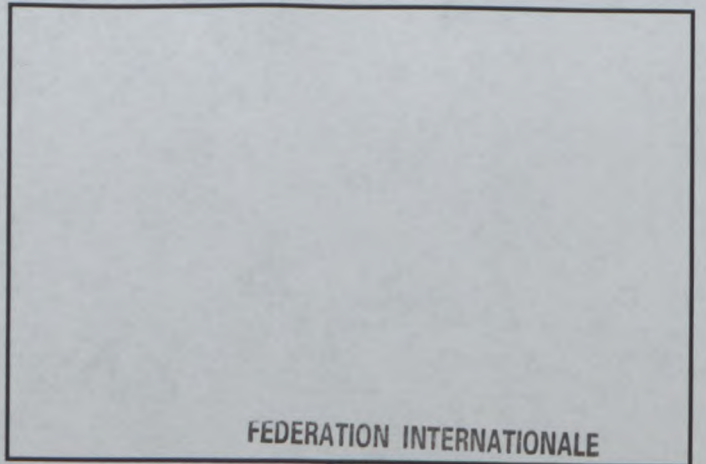

PHOTO N°



**FEDERATION INTERNATIONALE  
DE L'AUTOMOBILE**

8, place de la Concorde, 75008 Paris

Services Administratifs :

8 bis, rue Boissy d'Anglas, 75008 Paris





FEDERATION INTERNATIONALE DE L'AUTOMOBILE

Homologation N°

ST 27

VO

Extension N°

13/10 VO

FICHE D'EXTENSION D'HOMOLOGATION POUR DISPOSITIFS AERODYNAMIQUES EN SUPERTOURISME HOMOLOGATION EXTENSION FORM FOR AERODYNAMIC DEVICES IN SUPER TOURING

Homologation valable à partir du Homologation valid as from

01 AVR. 1998

Véhicule : Constructeur ADAM OPEL AG
Vehicle : Manufacturer

Modèle et type OPEL VECTRA B
Model and type

A) Voiture vue de 3/4 avant Car seen front 3/4 front



B) Voiture vue de 3/4 arrière Car seen from 3/4 rear



9. CARROSSERIE / BODYWORK

XVI) DISPOSITIF AVANT DEPOSE ET VU DE FACE AVEC DIMENSIONS DES OUVERTURES : DISMOUNTED FRONT DEVICE SEEN FROM FRONT WITH DIMENSIONS OF OPENINGS :

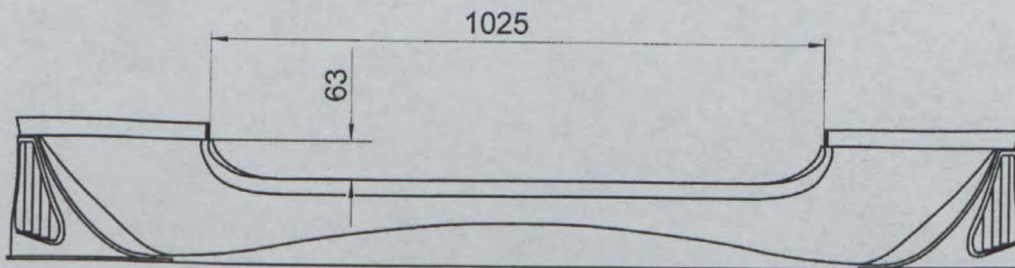

Tolerance ± 1%

Handwritten signature

FEDERATION INTERNATIONALE DE L'AUTOMOBILE

8, place de la Concorde, 75008 Paris

Services Administratifs :

8 bis, rue Boissy d'Anglas, 75008 Paris



ST 27

Marque  
Make **ADAM OPEL AG**

Modèle  
Model **OPEL VECTRA B**

13/10 VO

XVIII) DISPOSITIF AVANT DEPOSE ET VU DE COTE AVEC DIMENSIONS DES OUVERTURES :  
DISMOUNTED FRONT DEVICE IN SIDE VIEW WITH DIMENSIONS OF OPENINGS :

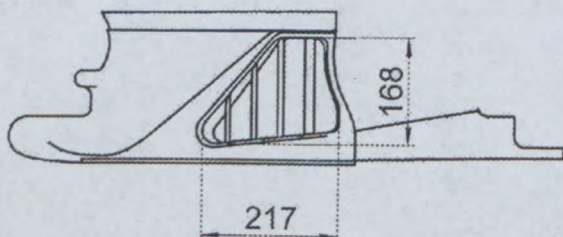
Tolerance  $\pm 1\%$ 

XXIII) DISPOSITIF AVANT EN PLACE ET VU DE FACE :  
MOUNTED FRONT DEVICE SEEN FROM FRONT :



XXIV) DISPOSITIF AVANT EN PLACE ET VU DE COTE :  
MOUNTED FRONT DEVICE IN SIDE VIEW :



**FEDERATION INTERNATIONALE  
DE L'AUTOMOBILE**

8, place de la Concorde, 75008 Paris  
Services Administratifs :

9 bis rue Boissy d'Anglas, 75008 Paris



ST 27

Marque  
Make **ADAM OPEL AG**

Modèle  
Model **OPEL VECTRA B**

13/10 VO

XVII) DISPOSITIF ARRIERE EN PLACE ET VU DE COTE :  
MOUNTED REAR DEVICE IN SIDE VIEW :



XIX) SECTION DU DISPOSITIF ARRIERE AU NIVEAU  
DE L'AXE LONGITUDINAL DE LA VOITURE :  
SECTION OF REAR DEVICE AT CAR'S CENTER  
LINE LEVEL :

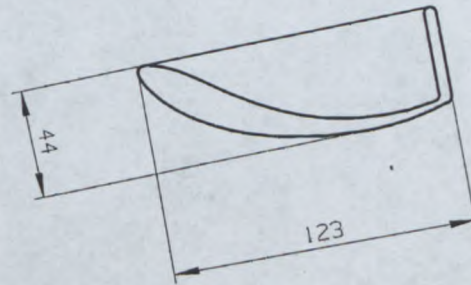

XX) DISPOSITIF ARRIERE EN PLACE ET VU DE DESSUS :  
MOUNTED REAR DEVICE SEEN FROM ABOVE :

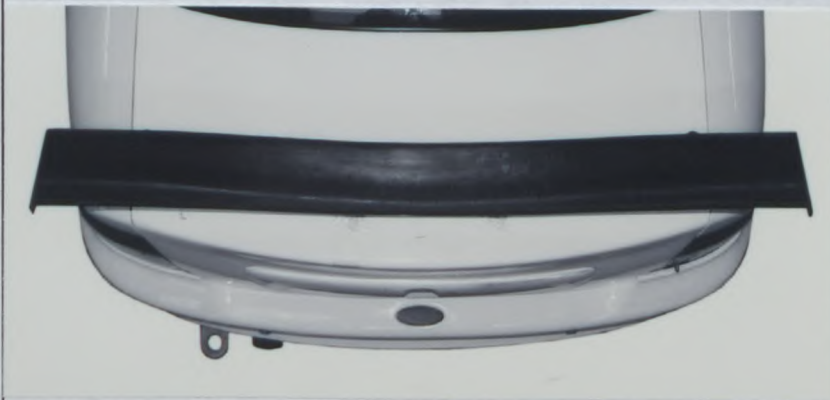

XXI) DISPOSITIF ARRIERE DEPOSE ET VU DE COTE :  
DISMOUNTED REAR DEVICE IN SIDE VIEW :



FEDERATION INTERNATIONALE  
DE L'AUTOMOBILE  
8, place de la Concorde, 75008 Paris  
Services Administratifs :  
8 bis, rue Boissy d'Anglas, 75008 Paris



Marque  
Make **ADAM OPEL AG**

Modèle  
Model **OPEL VECTRA B**

Homologation N°

**ST 27**

Extension N°

**13/10 VO**

XXII) DISPOSITIF ARRIERE DEPOSE ET VU DE DESSUS :  
DISMOUNTED REAR DEVICE SEEN FROM ABOVE :



Width = 1452 mm

Tolerance  $\pm 1\%$

902. Extérieur : p) Angle entre dispositif arrière et carrosserie  
Exterior : Angle between rear device and bodywork 17 +/- 1°



INFORMATIONS COMPLEMENTAIRES / COMPLEMENTARY INFORMATION :

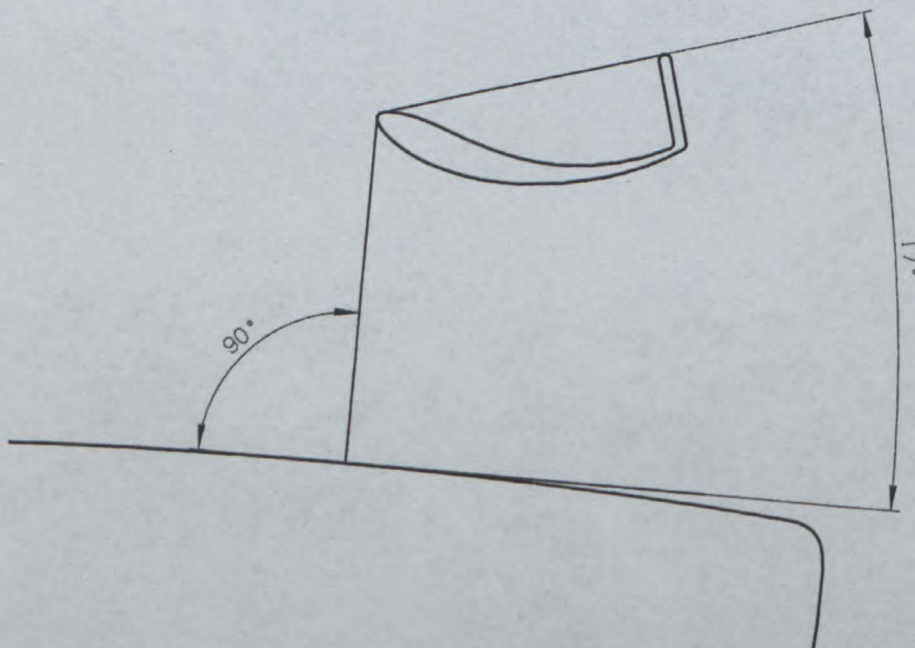

FEDERATION INTERNATIONALE  
DE L'AUTOMOBILE

8, place de la Concorde, 75008 Paris  
Services Administratifs :  
8 bis, rue Boissy d'Anglas, 75008 Paris





# FEDERATION INTERNATIONALE DE L'AUTOMOBILE

Homologation N°

ST - 027

Group **Supertourisme / Supertouring**

Extension N°

14 / 11 VO

## FICHE D'EXTENSION D'HOMOLOGATION POUR ARMATURE DE SECURITE FORM OF HOMOLOGATION EXTENSION FOR SAFETY CAGE

 **VO** Variante option / Option variant

 Véhicule : Constructeur  
 Vehicle : Manufacturer **ADAM OPEL AG**

 Modèle et type  
 Model and type **OPEL VECTRA B**

 Homologation valable à partir du  
 Homologation valid as from **01 AVR. 1998**

	Arceau principal Main rollbar	Entretoise longitudinale Longitudinal strut	Entretoise diagonale Diagonal strut	Arceau avant Front rollbar
Matériau Material	<b>Stahl / Steel</b>	<b>Stahl / Steel</b>	<b>Stahl / Steel</b>	<b>Stahl / Steel</b>
Diamètre extérieur Exterior diameter	<b>38.1 mm</b>	<b>25.4 mm</b>	<b>38.1 mm</b>	<b>38.1 mm</b>
Épaisseur de paroi Wall thickness	<b>1.6 mm</b>	<b>1.0 mm</b>	<b>0.9 mm</b>	<b>1.6 mm</b>
Limite élastique Elastic limit	<b>70 daN/mm<sup>2</sup></b>	<b>70 daN/mm<sup>2</sup></b>	<b>70 daN/mm<sup>2</sup></b>	<b>70 daN/mm<sup>2</sup></b>
Résistance à la traction Tensile strength	<b>80 daN/mm<sup>2</sup></b>	<b>80 daN/mm<sup>2</sup></b>	<b>80 daN/mm<sup>2</sup></b>	<b>80 daN/mm<sup>2</sup></b>

 Fabricant de l'armature  
 Structure manufacturer **SMS AG**

 Poids total y compris les fixations  
 Total weight including fixations **52** kg

 Arceau soudé  
 Welded rollbar

<input checked="" type="checkbox"/> oui yes	<input type="checkbox"/> non no
------------------------------------------------	------------------------------------

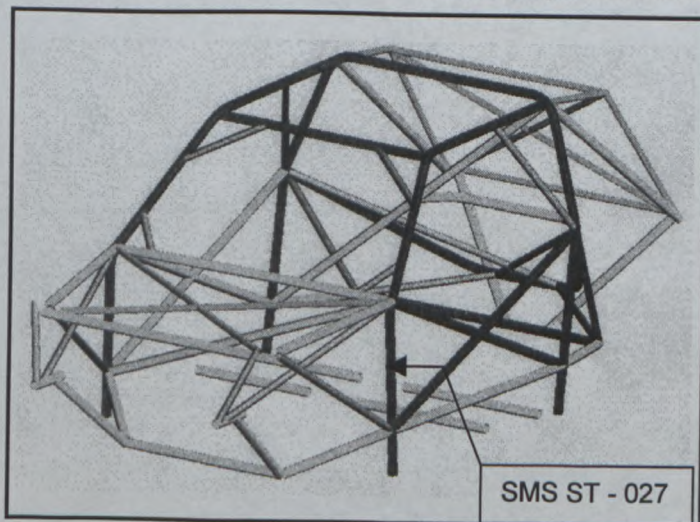
 Armature complète hors de la voiture (Indiquer par une flèche la position de la plaque d'identification)  
 Complete structure outside the car (Indicate the position of the identification plate with an arrow)

Nous attestons que la présente armature de sécurité répond aux dispositions de l'Annexe J de la FIA, en particulier en ce qui concerne ses implantations, ses connexions, et ses résistances aux contraintes.

We certify that the present safety structure complies with the conditions of the FIA Appendix J, in particular with regard to its attachments, its connections, and its stress resistances.

 Nom et signature du représentant du constructeur du véhicule  
 Name and signature of the car manufacturer representative

*Donatus Wichelhaus*  
 Donatus Wichelhaus  
 FEDERATION INTERNATIONALE DE L'AUTOMOBILE

8, place de la Concorde, 75008 Paris  
 Services Administratifs :  
 8 bis, rue Boissy d'Anglas, 75008 Paris



Marque  
Make **ADAM OPEL AG**

Modèle  
Model **OPEL VECTRA B**

Homologation N°

**ST - 027**

Extension N°

**14 / 1 1 VO**

PHOTO montrant l'identification du constructeur et le numéro de série de l'arceau.

PHOTO showing the manufacturer's identification and the series number of the rollbar.



PHOTO N° 1

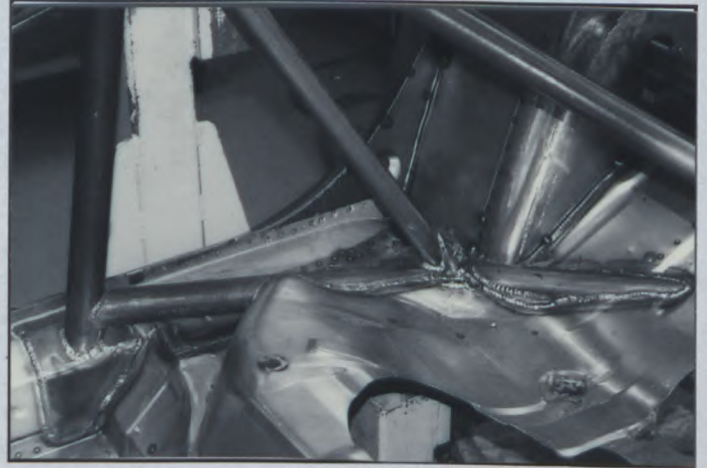

PHOTO N° 2

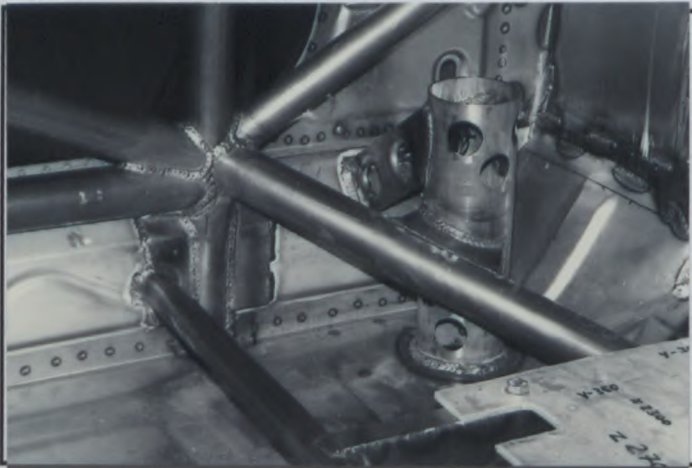

PHOTO N° 3

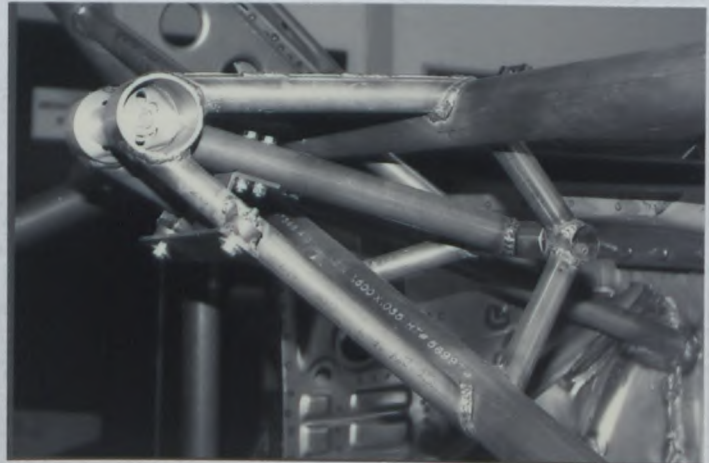
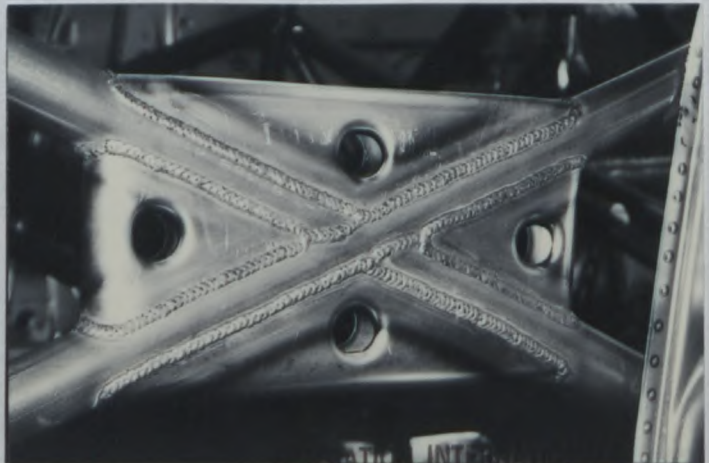

PHOTO N° 4



PHOTO N° 5



DE L'AUTOMOBILE

8, place de la Concorde, 75008 Paris

Services Administratifs :

8 bis, rue Boissy d'Anglas, 75008 Paris



Marque  
Make **ADAM OPEL AG**

Modèle  
Model **OPEL VECTRA B**

Homologation N°

**ST - 027**

Extension N°

**14 / 11 V0**

PHOTO N° 6

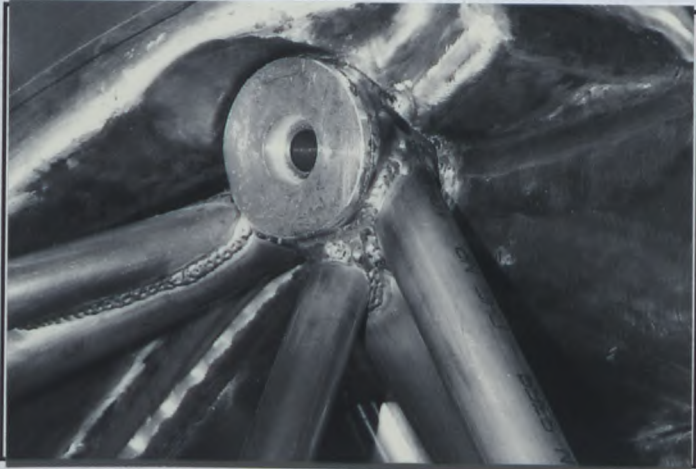

PHOTO N° 7



PHOTO N° 8

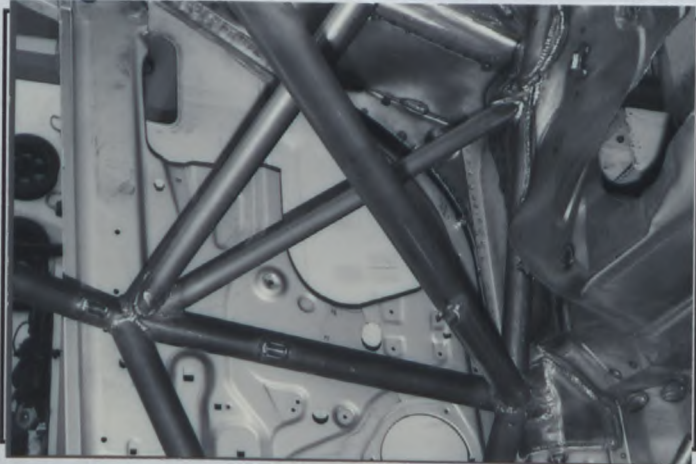

PHOTO N° 9

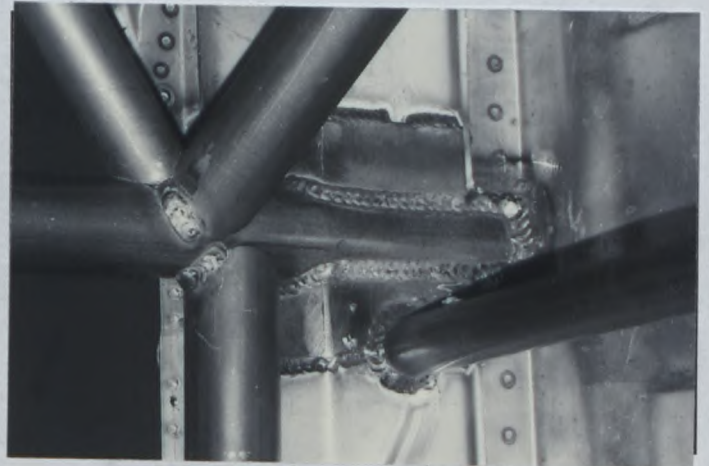
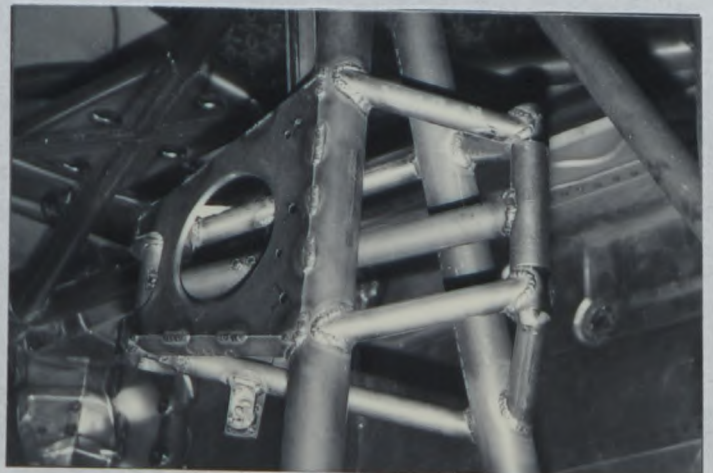

PHOTO N° 10



Reinforcement for the engine  
braket. (engine attachment)

PHOTO N° 11



**FEDERATION INTERNATIONALE  
DE L'AUTOMOBILE**

8, place de la Concorde, 75008 Paris  
Services Administratifs :

8 bis, rue Boissy d'Anglas, 75008 Paris

Homologation N°



Marque  
Make **ADAM OPEL AG**

Modèle  
Model **OPEL VECTRA B**

**ST - 027**

Extension N°

**14 / 11 V0**

PHOTO N° 12



PHOTO N°

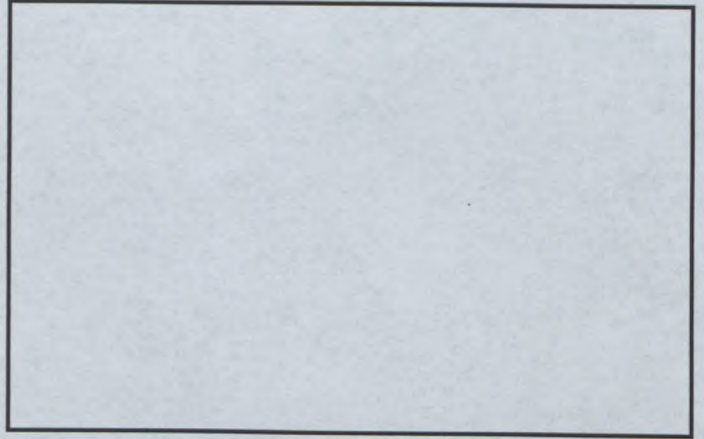

PHOTO N°

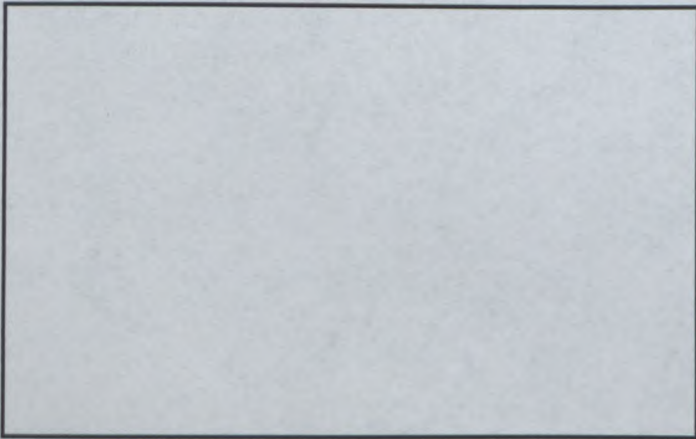

PHOTO N°

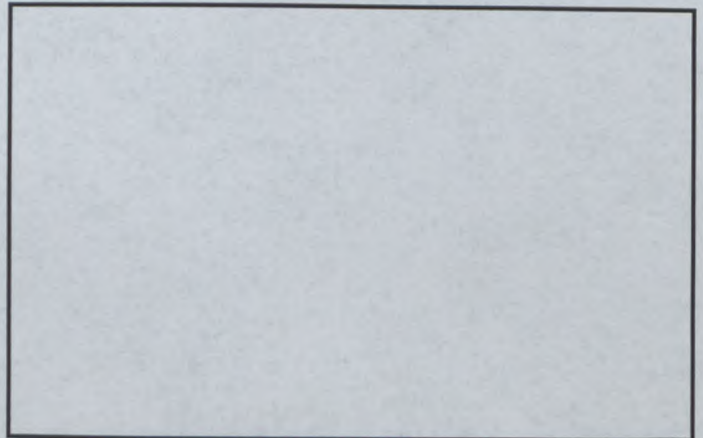

PHOTO N°

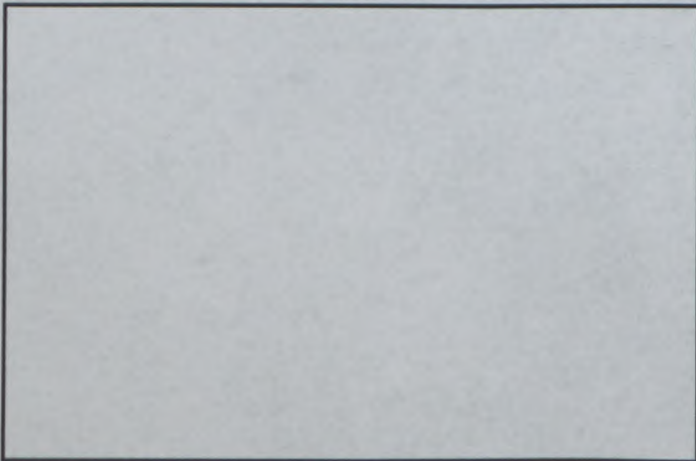
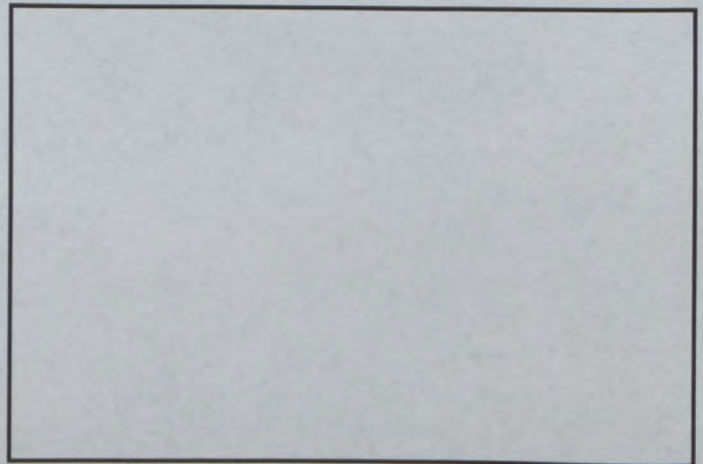

PHOTO N°







# FEDERATION INTERNATIONALE DE L'AUTOMOBILE

Homologation N°

ST 27

Groupe **ST**  
Group

Extension N°

15 / 0 4 ER

## FICHE D'EXTENSION D'HOMOLOGATION FOR OF HOMOLOGATION EXTENSION

- ES** Evolution sportive du type / Sporting evolution of the type
- ET** Evolution normale du type / Normal evolution of the type
- VF** Variante de fourniture / Supply variant
- VO** Variante option / Option variant
- ER** Erratum / Erratum

Véhicule : Constructeur  
 Vehicle : Manufacturer **ADAM OPEL AG**

Modèle et type  
 Model and type **OPEL VECTRA B**

Homologation valable à partir du  
 Homologation valid as from **01 JUL. 1998**

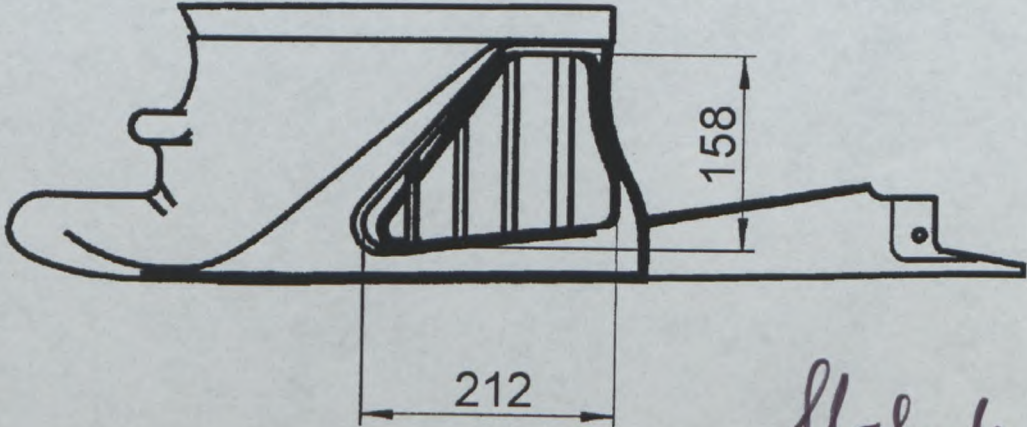
Page or ext.	Article	Description
13/10 VO		<p><u>XVIII) Dismounted front device in side view with dimensions of opening :</u></p> <p><u>Replace the drawing with the following one :</u></p> 

*Stalys*  
 FEDERATION INTERNATIONALE  
 DE L'AUTOMOBILE  
 8, place de la Concorde, 75008 Paris  
 Services Administratifs :  
 8 bis, rue Boissy d'Anglas, 75008 Paris